

# Aeroprakt Ltd.

24, Polevaya str., Kiev, Ukraine

Tel: 038 044 496-77-21

Fax: 038 044 496-77-31

e-mail: [air@prakt.kiev.ua](mailto:air@prakt.kiev.ua)

[www.aeroprakt.kiev.ua](http://www.aeroprakt.kiev.ua)

## AEROPRAKT-22L

### Illustrated Parts Catalog

### A22L-IPC-01

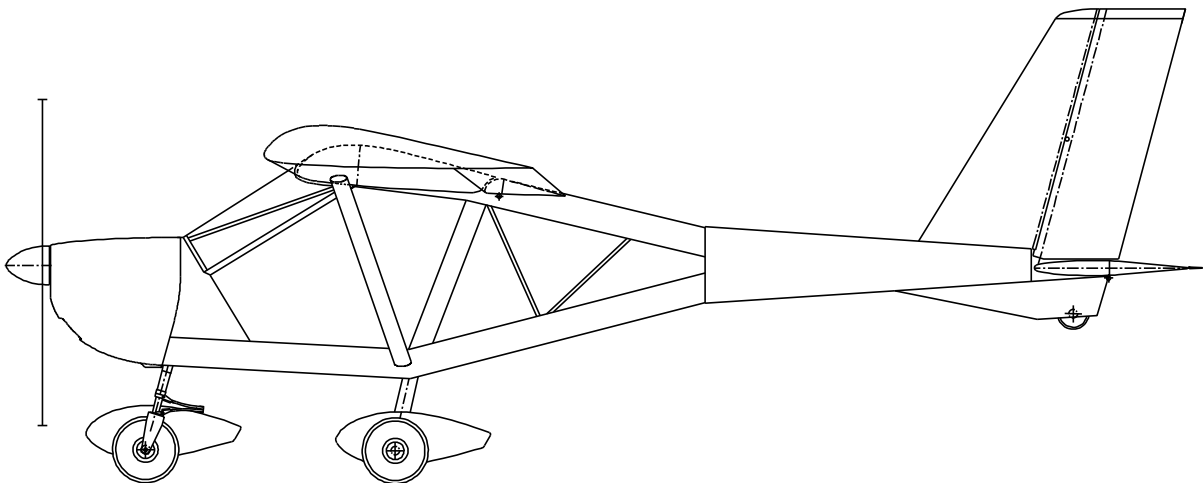

## Contents

<b>INTRODUCTION .....</b>	<b>3</b>
<b>1 AIRFRAME.....</b>	<b>4</b>
<b>2 LANDING GEAR .....</b>	<b>13</b>
<b>3 ENGINE AND ITS SYSTEMS .....</b>	<b>20</b>
<b>4 PROPELLER.....</b>	<b>24</b>
<b>5 AIRPLANE CONTROL SYSTEM .....</b>	<b>25</b>
<b>6 ELECTRICAL SYSTEM .....</b>	<b>28</b>
<b>7 SEATS, HARNESS BELTS, HEATING .....</b>	<b>30</b>
<b>8 CONSUMABLE MATERIALS .....</b>	<b>31</b>
<b>CATALOG STRUCTURE .....</b>	<b>33</b>

## INTRODUCTION

Significance of the catalog number (PART NO.) symbols:

### **A22L-AB-CDE F**

- A22L** - airplane type;
- AB** - catalog chapter number;
- CDE** - item number within catalog chapter;
- F** - version: «**R**» - right-hand, «**L**» - left-hand, or omitted if not “handed”.

# 1 AIRFRAME



NAME: **Fuselage with fin**  
PART NO: **A22L-01-001**  
WEIGHT: **34 kg**



NAME: **Tail boom assembly**  
PART NO: **A22L-01-002**  
WEIGHT: **10 kg**



NAME: **Firewall assembly**  
PART NO: **A22L-01-003**  
WEIGHT: **1.9 kg**



NAME: **Tail wheel (a set)**  
PART NO: **A22L-01-004**  
WEIGHT: **0.3 kg**



NAME: **Floor panel, forward**  
 PART NO: **A22L-01-005**  
 WEIGHT: **1.5 kg**

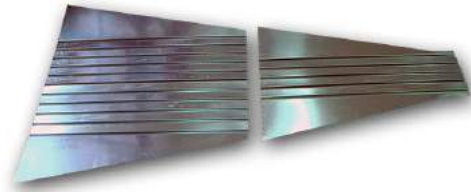

NAME: **Floor panel, rear**  
 PART NO: **A22L-01-006**  
 WEIGHT: **1.1 kg**



NAME: **Top cowling, not painted**  
 PART NO: **A22L-01-007**  
 WEIGHT: **1.2 kg**



NAME: **Top cowling**  
 PART NO: **A22L-01-008**  
 WEIGHT: **1.3 kg**



NAME: **Bottom cowling, not painted**  
 PART NO: **A22L-01-009**  
 WEIGHT: **1.9 kg**



NAME: **Bottom cowling**  
 PART NO: **A22L-01-010**  
 WEIGHT: **2.1 kg**



NAME: **Outer wing, not covered**  
 PART NO: **A22L-01-150 R**  
           **A22L-01-150 L**  
 WEIGHT: **17.5 kg**

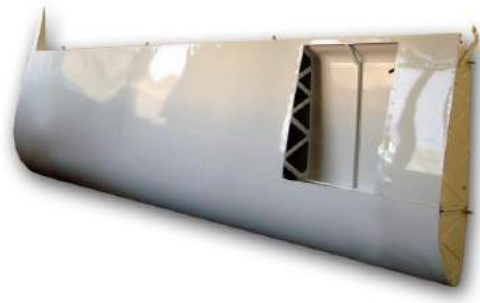

NAME: **Outer wing**  
 PART NO: **A22L-01-151 R**  
           **A22L-01-151 L**  
 WEIGHT: **19 kg**



NAME: **Flaperon, not covered**  
 PART NO: **A22L-01-152 R**  
           **A22L-01-152 L**  
 WEIGHT: **3.3 kg**



NAME: **Flaperon**  
 PART NO: **A22L-01-153 R**  
           **A22L-01-153 L**  
 WEIGHT: **4.1 kg**

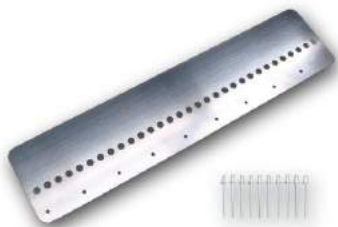

NAME: **Aileron trim tab, not painted**  
 PART NO: **A22L-01-154**  
 WEIGHT: **0.05 kg**

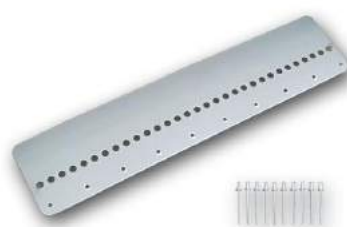







NAME: **Aileron trim tab**  
 PART NO: **A22L-01-155**  
 WEIGHT: **0.05 kg**



**NAME: Fuel tank**  
**PART NO: A22L-01-156 R**  
**A22L-01-156 L**  
**WEIGHT: 3.4 kg**



**NAME: Fuel tank cap**  
**PART NO: A22L-01-157**  
**WEIGHT: 0.06 kg**

 <p>NAME: <b>Wing strut</b>          PART NO: <b>A22L-01-158 R</b>                    <b>A22L-01-158 L</b>          WEIGHT: <b>2.8 kg</b></p>	 <p>NAME: <b>Wing strut fairings (a set)</b>          PART NO: <b>A22L-01-159</b>          WEIGHT: <b>0.5 kg</b></p>
 <p>NAME: <b>Pitot tube</b>          PART NO: <b>A22L-01-160</b>          WEIGHT: <b>0.11 kg</b></p>	 <p>NAME: <b>Wing tip</b>          PART NO: <b>A22L-01-161 R</b>                    <b>A22L-01-161 L</b>          WEIGHT: <b>1.4 kg</b></p>
 <p>NAME: <b>Wing covering (DIATEX fabric)</b>          PART NO: <b>A22L-01-162</b>          WEIGHT: <b>0.4 kg</b></p>	 <p>NAME: <b>Flaperon covering (DIATEX fabric)</b>          PART NO: <b>A22L-01-163</b>          WEIGHT: <b>0.27 kg</b></p>





NAME: **Stabilizer, not painted**  
 PART NO: **A22L-01-300**  
 WEIGHT: **6.3 kg**



NAME: **Stabilizer**  
 PART NO: **A22L-01-301**  
 WEIGHT: **6.7 kg**

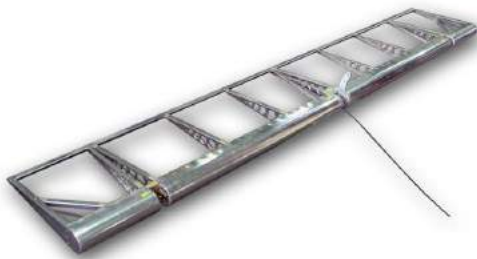

NAME: **Elevator, not covered**  
 PART NO: **A22L-01-302**  
 WEIGHT: **2.2 kg**



NAME: **Elevator**  
 PART NO: **A22L-01-303**  
 WEIGHT: **2.8 kg**



NAME: **Elevator trim tab, not painted**  
 PART NO: **A22L-01-304**  
 WEIGHT: **0.17 kg**



NAME: **Elevator trim tab**  
 PART NO: **A22L-01-305**  
 WEIGHT: **0.2 kg**



NAME: **Stabilizer end ribs**  
 PART NO: **A22L-01-306**  
 WEIGHT: **0.16 kg**



NAME: **Elevator end ribs**  
 PART NO: **A22L-01-307**  
 WEIGHT: **0.07 kg**



NAME: **Elevator tips**  
 PART NO: **A22L-01-308**  
 WEIGHT: **0.6 kg**



NAME: **Elevator covering (DIATEX fabric)**  
 PART NO: **A22L-01-309**  
 WEIGHT: **0.2 kg**



NAME: **Fin and fin spar**  
 PART NO: **A22L-01-450**  
 WEIGHT: **2 kg**

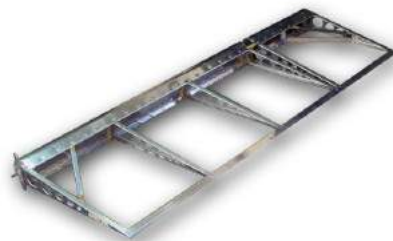

NAME: **Rudder, not covered**  
 PART NO: **A22L-01-451**  
 WEIGHT: **1.1 kg**



**NAME: Rudder**  
**PART NO: A22L-01-452**  
**WEIGHT: 1.4 kg**



**NAME: Rudder covering (DIATEX fabric)**  
**PART NO: A22L-01-453**  
**WEIGHT: 0.13 kg**



**NAME: Windscreen glass**  
**PART NO: A22L-01-600**  
**WEIGHT: 3.2 kg**



**NAME: Windscreen glass edging**  
**PART NO: A22L-01-601**  
**WEIGHT: 0.45 kg**



**NAME: Rear glass edging**  
**PART NO: A22L-01-602**  
**WEIGHT: 0.28 kg**



**NAME: Gas strut**  
**PART NO: A22L-01-750**  
**WEIGHT: 0.25 kg**



NAME: **Door**  
 PART NO: **A22L-01-751 R**  
           **A22L-01-751 L**  
 WEIGHT: **3.7 kg**



NAME: **Door with big sliding window**  
 PART NO: **A22L-01-752 R**  
           **A22L-01-752 L**  
 WEIGHT: **4.5 kg**



NAME: **Door glass**  
 PART NO: **A22L-01-753 R**  
           **A22L-01-753 L**  
 WEIGHT: **2 kg**



NAME: **Vent scoop**  
 PART NO: **A22L-01-754**  
 WEIGHT: **0.02 kg**

## 2 LANDING GEAR



NAME: **Nose LG leg for 6x6 wheel**  
 PART NO: **A22L-02-001**  
 WEIGHT: **4.1 kg**



NAME: **Nose LG leg for 5x6 wheel**  
 PART NO: **A22L-02-002**  
 WEIGHT: **4.0 kg**



NAME: **Nose wheel fork for 6x6 wheel**  
 PART NO: **A22L-02-003**  
 WEIGHT: **0.8 kg**



NAME: **Nose wheel fork for 5x6 wheel**  
 PART NO: **A22L-02-004**  
 WEIGHT: **0.7 kg**



NAME: **Nose LG leg strap for 6x6 wheel**  
 PART NO: **A22L-02-005**  
 WEIGHT: **0.03 kg**



NAME: **Nose LG leg strap for 5x6 wheel**  
 PART NO: **A22L-02-006**  
 WEIGHT: **0.03 kg**



NAME: **Nose LG leg rod**  
 PART NO: **A22L-02-007**  
 WEIGHT: **0.85 kg**



NAME: **Nose LG leg spring**  
 PART NO: **A22L-02-008**  
 WEIGHT: **1 kg**



NAME: **Nose LG leg support, upper**  
 PART NO: **A22L-02-009**  
 WEIGHT: **0.23 kg**



NAME: **Nose LG leg support, lower**  
 PART NO: **A22L-02-010**  
 WEIGHT: **0.66 kg**



NAME: **Main LG leg assembly (6x6 wheel)**  
 PART NO: **A22L-02-150 R**  
           **A22L-02-150 L**  
 WEIGHT: **5 kg**



NAME: **Main LG leg assembly (5x6 wheel)**  
 PART NO: **A22L-02-151 R**  
           **A22L-02-151 L**  
 WEIGHT: **5 kg**



NAME: **Main LG leg spring**  
 PART NO: **A22L-02-152**  
 WEIGHT: **4.5 kg**



NAME: **Main LG leg fitting**  
 PART NO: **A22L-02-153 R**  
           **A22L-02-153 L**  
 WEIGHT: **0.14 kg**



NAME: **Main LG leg brace**  
 PART NO: **A22L-02-154 R**  
           **A22L-02-154 L**  
 WEIGHT: **0.25 kg**



NAME: **Main LG leg bracket, upper**  
 PART NO: **A22L-02-155 R**  
           **A22L-02-155 L**  
 WEIGHT: **0.31 kg**



NAME: **Main LG leg bracket, lower**  
 PART NO: **A22L-02-156 R**  
           **A22L-02-156 L**  
 WEIGHT: **0.43 kg**



NAME: **Main LG pads and fittings (a set)**  
 PART NO: **A22L-02-157**  
 WEIGHT: **0.35 kg**

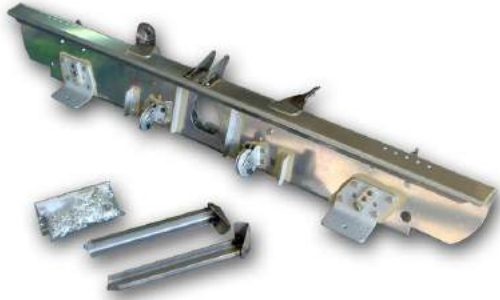

NAME: **Main LG beam (a set)**  
 PART NO: **A22L-02-158**  
 WEIGHT: **5 kg**



NAME: **Main LG leg fairings (a set)**  
 PART NO: **A22L-02-159**  
 WEIGHT: **0.35 kg**



NAME: **6x6 nose wheel fairing, not painted**  
 PART NO: **A22L-02-300**  
 WEIGHT: **0.7 kg**



NAME: **6x6 nose wheel fairing**  
 PART NO: **A22L-02-301**  
 WEIGHT: **0.75 kg**



NAME: **6x6 main wheel fairing, not painted**  
 PART NO: **A22L-02-302 R**  
                   **A22L-02-302 L**  
 WEIGHT: **0.76 kg**



NAME: **6x6 main wheel fairing**  
 PART NO: **A22L-02-303 R**  
                   **A22L-02-303 L**  
 WEIGHT: **0.8 kg**





NAME: **5x6 nose wheel fairing, not painted**  
 PART NO: **A22L-02-304**  
 WEIGHT: **0.5 kg**



NAME: **5x6 nose wheel fairing**  
 PART NO: **A22L-02-305**  
 WEIGHT: **0.55 kg**



NAME: **5x6 main wheel fairing, not painted**  
 PART NO: **A22L-02-306 R**  
           **A22L-02-306 L**  
 WEIGHT: **0.5 kg**



NAME: **5x6 main wheel fairing**  
 PART NO: **A22L-02-307 R**  
           **A22L-02-307 L**  
 WEIGHT: **0.55 kg**

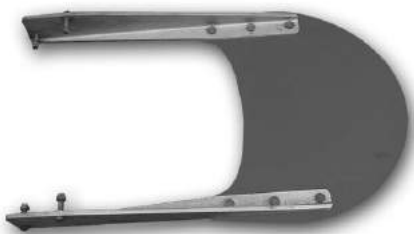

NAME: **6x6 nose wheel mud-screen**  
 PART NO: **A22L-02-450**  
 WEIGHT: **0.35 kg**



NAME: **6x6 main wheel mud-screen**  
 PART NO: **A22L-02-451 R**  
           **A22L-02-451 L**  
 WEIGHT: **0.37 kg**



NAME: **5x6 nose wheel mud-screen**  
 PART NO: **A22L-02-452**  
 WEIGHT: **0.3 kg**



NAME: **5x6 main wheel mud-screen**  
 PART NO: **A22L-02-453 R**  
                   **A22L-02-453 L**  
 WEIGHT: **0.32 kg**



NAME: **Set of 6x6 wheels with brakes**  
 PART NO: **A22L-02-600**  
 WEIGHT: **13.5 kg**



NAME: **Set of 5x6 wheels with brakes**  
 PART NO: **A22L-02-601**  
 WEIGHT: **11 kg**



NAME: **Master brake cylinder**  
 PART NO: **A22L-02-750**  
 WEIGHT: **0.2 kg**



NAME: **Braking system fittings (a set)**  
 PART NO: **A22L-02-751**  
 WEIGHT: **0.13 kg**



NAME: **Braking system tubing (a set)**  
PART NO: **A22L-02-752**  
WEIGHT: **0.25 kg**



NAME: **Braking system expansion tank**  
PART NO: **A22L-02-753**  
WEIGHT: **0.04 kg**

### 3 ENGINE AND ITS SYSTEMS

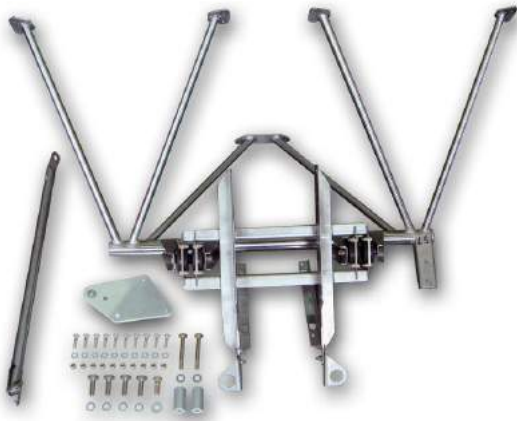

NAME: **Engine mount (a set)**  
 PART NO: **A22L-03-001**  
 WEIGHT: **4.9 kg**



NAME: **Engine mount shock absorber**  
 PART NO: **A22L-03-002**  
 WEIGHT: **0.07 kg**



NAME: **Intake airbox (a set)**  
 PART NO: **A22L-03-150**  
 WEIGHT: **0.73 kg**



NAME: **Choke controls (a set)**  
 PART NO: **A22L-03-151**  
 WEIGHT: **0.07 kg**





NAME: **Oil system lines (a set)**  
 PART NO: **A22L-03-450**  
 WEIGHT: **0.33 kg**



NAME: **Cooling system hoses (a set)**  
 PART NO: **A22L-03-600**  
 WEIGHT: **0.68 kg**

 <p>NAME: <b>Exhaust system (100 hp, a set)</b>          PART NO: <b>A22L-03-750</b>          WEIGHT: <b>4.5 kg</b></p>	 <p>NAME: <b>Exhaust muffler (100 hp)</b>          PART NO: <b>A22L-03-751</b>          WEIGHT: <b>2.5 kg</b></p>
 <p>NAME: <b>Exhaust pipe 1st cylinder (100 hp)</b>          PART NO: <b>A22L-03-752</b>          WEIGHT: <b>0.5 kg</b></p>	 <p>NAME: <b>Exhaust pipe 2nd cylinder (100 hp)</b>          PART NO: <b>A22L-03-753</b>          WEIGHT: <b>0.54 kg</b></p>
 <p>NAME: <b>Exhaust pipe 3rd cylinder (100 hp)</b>          PART NO: <b>A22L-03-754</b>          WEIGHT: <b>0.4 kg</b></p>	 <p>NAME: <b>Exhaust pipe 4th cylinder (100 hp)</b>          PART NO: <b>A22L-03-755</b>          WEIGHT: <b>0.35 kg</b></p>

 <p>NAME: <b>Exhaust system (80 hp, a set)</b>          PART NO: <b>A22L-03-756</b>          WEIGHT: <b>4.4 kg</b></p>	 <p>NAME: <b>Exhaust muffler (80 hp)</b>          PART NO: <b>A22L-03-757</b>          WEIGHT: <b>2.4 kg</b></p>
 <p>NAME: <b>Exhaust pipe 1st cylinder (80 hp)</b>          PART NO: <b>A22L-03-758</b>          WEIGHT: <b>0.5 kg</b></p>	 <p>NAME: <b>Exhaust pipe 2nd cylinder (80 hp)</b>          PART NO: <b>A22L-03-759</b>          WEIGHT: <b>0.54 kg</b></p>
 <p>NAME: <b>Exhaust pipe 3rd cylinder (80 hp)</b>          PART NO: <b>A22L-03-760</b>          WEIGHT: <b>0.4 kg</b></p>	 <p>NAME: <b>Exhaust pipe 4th cylinder (80 hp)</b>          PART NO: <b>A22L-03-761</b>          WEIGHT: <b>0.35 kg</b></p>



**NAME: Exhaust system springs (a set)**  
**PART NO: A22L-03-762**  
**WEIGHT: 0.16 kg**



**NAME: Bushings for EGT sensors (a set)**  
**PART NO: A22L-03-763**  
**WEIGHT: 0.06 kg**

## 4 PROPELLER



NAME: **Propeller spinner, not finished (a set)**  
PART NO: **A22L-04-001**  
WEIGHT: **0.6 kg**



NAME: **Propeller spinner (a set)**  
PART NO: **A22L-04-002**  
WEIGHT: **0.58 kg**



NAME: **KIEVPROP propeller (a set)**  
PART NO: **A22L-04-151**  
WEIGHT: **3.95 kg**



NAME: **KIEVPROP propeller blade**  
PART NO: **A22L-04-152**  
WEIGHT: **0.75 kg**



## 5 AIRPLANE CONTROL SYSTEM



NAME: Yokes with control column (a set)  
PART NO: A22L-05-001  
WEIGHT: 4.3 kg



NAME: Central stick with "Y" handle (a set)  
PART NO: A22L-05-002  
WEIGHT: 1.9 kg



NAME: Central stick with "I" handle (a set)  
PART NO: A22L-05-003  
WEIGHT: 0.9 kg



NAME: Torque shaft (yokes)  
PART NO: A22L-05-150  
WEIGHT: 0.8 kg



NAME: Torque shaft (stick)  
PART NO: A22L-05-151  
WEIGHT: 0.5 kg



NAME: Vertical rod L=960 mm  
PART NO: A22L-05-152  
WEIGHT: 0.37 kg



NAME: **Aileron shaft**  
 PART NO: **A22L-05-153 R**  
**A22L-05-153 L**  
 WEIGHT: **0.42 kg**



NAME: **Elevator rod 1 (yokes), L=993 mm**  
 PART NO: **A22L-05-300**  
 WEIGHT: **0.35 kg**



NAME: **Elevator rod 1 (stick) L=506 mm**  
 PART NO: **A22L-05-301**  
 WEIGHT: **0.16 kg**



NAME: **Elevator rod 2 L=1520 mm**  
 PART NO: **A22L-05-302**  
 WEIGHT: **0.6 kg**



NAME: **Elevator rod 3 L=2140 mm**  
 PART NO: **A22L-05-303**  
 WEIGHT: **0.75 kg**



NAME: **Rudder cables (a set)**  
 PART NO: **A22L-05-450**  
 WEIGHT: **0.6 kg**



NAME: **Nose LG leg rod**  
PART NO: **A22L-05-451 R**  
**A22L-05-451 L**  
WEIGHT: **0.1 kg**



NAME: **Rod end (fork)**  
PART NO: **A22L-05-452**  
WEIGHT: **0.05 kg**

## 6 ELECTRICAL SYSTEM



NAME: **Landing light, BOSH (a set)**  
PART NO: **A22L-06-001**  
WEIGHT: **0.35 kg**



NAME: **Condenser 2200  $\mu$ F 25V**  
PART NO: **A22L-06-002**  
WEIGHT: **0.1 kg**



NAME: **Switch guard**  
PART NO: **A22L-06-003**  
WEIGHT: **0.004 kg**



NAME: **Toggle switch**  
PART NO: **A22L-06-004**  
WEIGHT: **0.03 kg**



NAME: **Battery straps (a set)**  
PART NO: **A22L-06-005**  
WEIGHT: **0.05 kg**



NAME: **Fuel level indicator**  
PART NO: **A22L-06-150**  
WEIGHT: **0.14 kg**

 <p>NAME: Fuel level sensor PART NO: A22L-06-151 R A22L-06-151 L WEIGHT: 0.11 kg</p>	
---	--

## 7 SEATS, HARNESS BELTS, HEATING



NAME: **Seats (a set)**  
 PART NO: **A22L-07-001**  
 WEIGHT: **3.6 kg**



NAME: **Seat framework**  
 PART NO: **A22L-07-002**  
 WEIGHT: **1 kg**



NAME: **Seat cushion**  
 PART NO: **A22L-07-003**  
 WEIGHT: **0.65 kg**



NAME: **Harness belts (a set)**  
 PART NO: **A22L-07-150**  
 WEIGHT: **1.4 kg**



NAME: **Cockpit heating system**  
 PART NO: **A22L-07-300**  
 WEIGHT: **0.7 kg**

## 8 CONSUMABLE MATERIALS



NAME: **ATF hydraulic fluid, 5 l**  
 PART NO: **A22L-08-001**  
 WEIGHT: **4.5 kg**

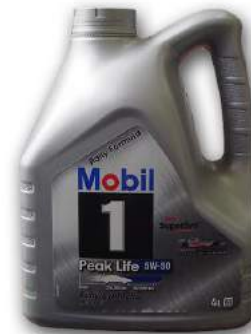

NAME: **Mobil 1 (5W-50) engine oil, 4 l**  
 PART NO: **A22L-08-002**  
 WEIGHT: **3.6 kg**



NAME: **Mobil antifreeze (concentrated), 5 l**  
 PART NO: **A22L-08-003**  
 WEIGHT: **5.5 kg**



NAME: **3M polyurethane sealant, 310 ml**  
 PART NO: **A22L-08-150**  
 WEIGHT: **0.35 kg**



NAME: **Terostat-8517H primer, 25 ml**  
 PART NO: **A22L-08-300**  
 WEIGHT: **0.06 kg**



NAME: **Glasurit primer, 0.5 l + 1.0 l**  
 PART NO: **A22L-08-301**  
 WEIGHT: **1.75 kg**



**NAME: EkoFill primer, 3.8 l**  
**PART NO: A22L-08-302**  
**WEIGHT: 4.9 kg**



## CATALOG STRUCTURE

### A22L

#### 01 – AIRFRAME

- 001 – 149 – fuselage
- 150 – 299 – wing
- 300 – 449 – stabilizer
- 450 – 599 – fin
- 600 – 749 – glass
- 750 – 899 – doors

#### 02 – LANDING GEAR

- 001 – 149 – nose leg
- 150 – 299 – main leg
- 300 – 499 – fairings
- 450 – 599 – mud-screens
- 600 – 749 – wheels
- 750 – 899 – brakes

#### 03 – ENGINE AND ITS SYSTEMS

- 001 – 149 – engine mount
- 150 – 299 – control system
- 300 – 499 – fuel system
- 450 – 599 – oil system
- 600 – 749 – cooling system
- 750 – 899 – exhaust system

#### 04 – PROPELLER

- 001 – 149 – spinner
- 150 – 299 – propeller

#### 05 – AIRPLANE CONTROL SYSTEM

- 001 – 149 – control system levers
- 150 – 299 – aileron control system
- 300 – 499 – elevator control system
- 450 – 599 – rudder control system

#### 06 – ELECTRICAL SYSTEM

- 001 – 149 – electrical equipment
- 150 – 299 – instruments

#### 07 – SEATS, HARNESS BELTS, HEATING

- 001 – 149 – seats
- 150 – 299 – harness belts
- 300 – 499 – heating

#### 08 – CONSUMABLE MATERIALS

- 001 – 149 – oils and fluids
- 150 – 299 – sealants
- 300 – 499 – primers
- 450 – 599 – paints