

Aeroprakt Ltd.

24, Polevaya str., Kiev, Ukraine

Tel: 038 044 496-77-21

Fax: 038 044 496-77-31

e-mail: air@prakt.kiev.ua

www.aeroprakt.kiev.ua

AEROPRAKT-22LS (A22L2)

Illustrated Parts Catalog

Иллюстрированный каталог частей

A22LS-(A22L2)-IPC-06

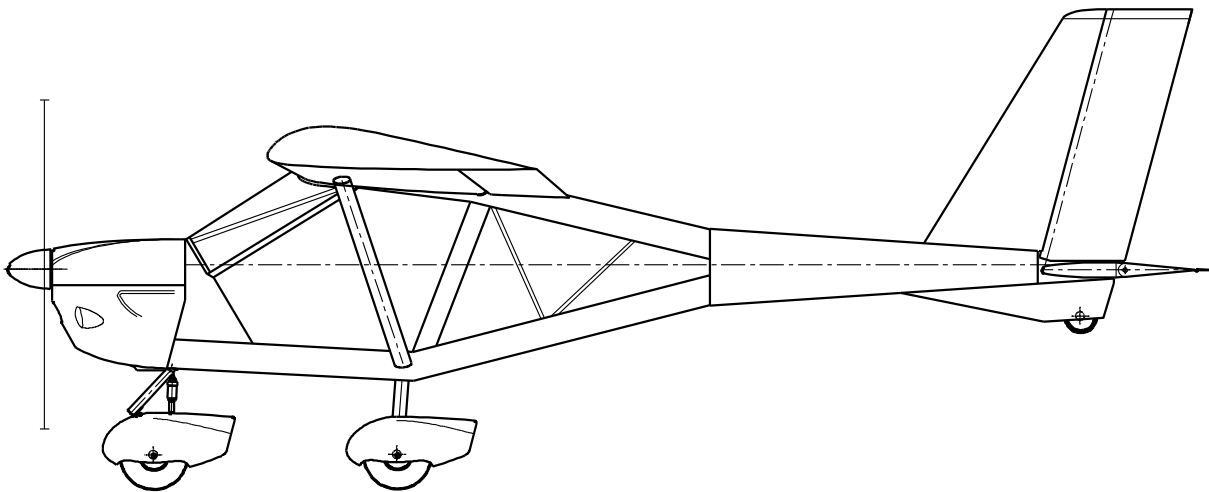

Contents / Содержание

INTRODUCTION / ВВЕДЕНИЕ	3
01. AIRFRAME / ПЛАНЕР	4
FUSELAGE / ФЮЗЕЛЯЖ.....	4
WING / КРЫЛО.....	9
HORIZONTAL EMPENNAGE / ГОРИЗОНТАЛЬНОЕ ОПЕРЕНИЕ	14
VERTICAL EMPENNAGE / ВЕРТИКАЛЬНОЕ ОПЕРЕНИЕ	16
GLASS / ОСТЕКЛЕНИЕ	17
DOORS / ДВЕРИ	18
02. LANDING GEAR / ШАССИ	20
NOSE LEG / ПЕРЕДНЯЯ СТОЙКА.....	20
MAIN LEG / ОСНОВНАЯ СТОЙКА	24
FAIRINGS / ОБТЕКАТЕЛИ	25
MUD-SCREENS / ЩИТКИ.....	26
WHEELS / КОЛЕСА	28
BRAKES / ТОРМОЗА	30
03. ENGINE AND ITS SYSTEMS / ДВИГАТЕЛЬ И ЕГО СИСТЕМЫ	32
ENGINE MOUNT / МОТОРАМА.....	32
CONTROL SYSTEM / СИСТЕМА УПРАВЛЕНИЯ	33
FUEL SYSTEM / ТОПЛИВНАЯ СИСТЕМА	39
OIL SYSTEM / МАСЛОСИСТЕМА	40
COOLING SYSTEM / СИСТЕМА ОХЛАЖДЕНИЯ.....	41
EXHAUST SYSTEM / ВЫХЛОПНАЯ СИСТЕМА	42
04. PROPELLER / ВОЗДУШНЫЙ ВИНТ.....	44
SPINNER / КОК.....	44
PROPELLER / ВИНТ	45
05. AIRPLANE CONTROL SYSTEM / СИСТЕМА УПРАВЛЕНИЯ САМОЛЕТОМ	46
CONTROL SYSTEM LEVERS / ПОСТЫ СИСТЕМЫ УПРАВЛЕНИЯ.....	46
AILERON CONTROL SYSTEM / СИСТЕМА УПРАВЛЕНИЯ ЭЛЕРОНАМИ	49
ELEVATOR CONTROL SYSTEM / СИСТЕМА УПРАВЛЕНИЯ РУ	53
RUDDER CONTROL SYSTEM / СИСТЕМА УПРАВЛЕНИЯ РН.....	56
AUTOPILOT / АВТОПИЛОТ	57
06. ELECTRICAL SYSTEM / ЭЛЕКТРОСИСТЕМА.....	58
ELECTRICAL EQUIPMENT / ЭЛЕКТРООБОРУДОВАНИЕ.....	58
INSTRUMENTS / ПРИБОРНОЕ ОБОРУДОВАНИЕ	60
07. SOCKRIT EQUIPMENT / ОБОРУДОВАНИЕ КАБИНЫ.....	62
SEATS / СИДЕНЬЯ	62
HARNES BELTS / ПРИВЯЗНАЯ СИСТЕМА	63
HEATING / ОТОПЛЕНИЕ	64
INTERIOR AND BAGGAGE COMPARTMENT / ИНТЕРЬЕР И БАГАЖНИК	65
08. CONSUMABLE MATERIALS / РАСХОДНЫЕ МАТЕРИАЛЫ	66
OILS AND FLUIDS / МАСЛА И ЖИДКОСТИ СИСТЕМ	66
SEALANTS / ГЕРМЕТИКИ	67
PRIMERS AND PAINTS / ГРУНТЫ И КРАСКИ	68
CATALOG STRUCTURE / СТРУКТУРА КАТАЛОГА.....	69

INTRODUCTION / ВВЕДЕНИЕ

Significance of the catalog number (PART NO.) symbols:

Значение цифр каталожного номера (НОМЕР):

A22Lx-AB-CDEF G

A22Lx - airplane type / тип самолета: **A22LS/A22L2**;

AB - catalog chapter number / номер раздела каталога;

CDEF - item number within catalog chapter / номер позиции в разделе каталога

G - version: «R» - right-hand, «L» - left-hand, or omitted if not “handed” /



исполнение: «R» - правое, «L» - левое, либо отсутствует.



01. AIRFRAME / ПЛАНЕР

Fuselage / Фюзеляж

	<p>NAME: Fuselage with fin, not painted, assembled by agreement (A22LS only) PART NO.: A22LS-01-0001 WEIGHT: 47.2 kg</p>
	<p>NAME: Fuselage with fin, not painted, assembled by agreement (A22L2 only) PART NO.: A22L2-01-0001 WEIGHT: 42.8 kg</p>
	<p>NAME: Tail boom assembly, not painted PART NO.: A22LS-01-0002 WEIGHT: 10 kg</p>
	<p>NAME: Top cowling, not painted PART NO.: A22LS-01-0003 WEIGHT: 1.55 kg</p>

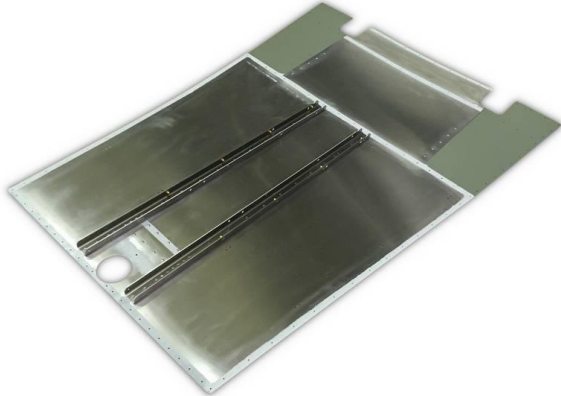
	<p>NAME: Top cowling, painted PART NO.: A22LS-01-0004 WEIGHT: 1.694 kg</p> <hr/> <p>НАИМЕН.: Верхняя часть капота, окрашенная НОМЕР: A22LS-01-0004 ВЕС: 1.694 кг</p>
	<p>NAME: Bottom cowling, not painted PART NO.: A22LS-01-0005 WEIGHT: 2.05 kg</p> <hr/> <p>НАИМЕН.: Нижняя часть капота, неокрашенная НОМЕР: A22LS-01-0005 ВЕС: 2.05 кг</p>
	<p>NAME: Bottom cowling, painted PART NO.: A22LS-01-0006 WEIGHT: 2.235 kg</p> <hr/> <p>НАИМЕН.: Нижняя часть капота, окрашенная НОМЕР: A22LS-01-0006 ВЕС: 2.235 кг</p>
	<p>NAME: Cowling lock pin set PART NO.: A22LS-01-0014 WEIGHT: 0.035 kg</p> <hr/> <p>НАИМЕН.: Комплект штифтов замков капота НОМЕР: A22LS-01-0014 ВЕС: 0.035 кг</p>

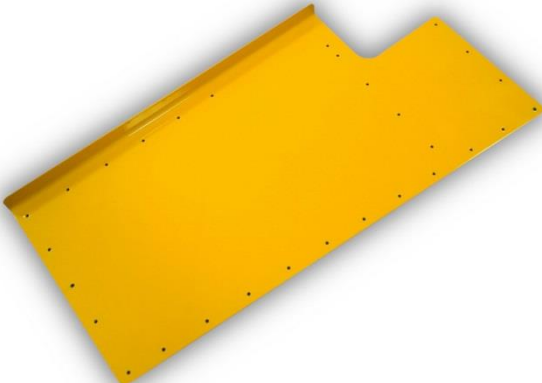
	<p>NAME: Cowling lock socket set PART NO.: A22LS-01-0015 WEIGHT: 0.034 kg</p>
	<p>НАИМЕН.: Комплект гнезд замков капота НОМЕР: A22LS-01-0015 ВЕС: 0.034 кг</p>
	<p>NAME: Firewall assembly, not painted (A22LS only) PART NO.: A22LS-01-0007 WEIGHT: 4.24 kg</p>
	<p>НАИМЕН.: Первый шпангоут в сборе, неокрашенный (только для A22LS) НОМЕР: A22LS-01-0007 ВЕС: 4.24 кг</p>
	<p>NAME: Firewall assembly, not painted (A22L2 only) PART NO.: A22L2-01-0002 WEIGHT: 3.14 kg</p>
	<p>НАИМЕН.: Первый шпангоут в сборе, неокрашенный (только для A22L2) НОМЕР: A22L2-01-0002 ВЕС: 3.14 кг</p>
	<p>NAME: Floor panel assembly, forward, not painted PART NO.: A22LS-01-0008 WEIGHT: 2.84 kg</p>
	<p>НАИМЕН.: Панель пола в сборе, передняя, неокрашенная НОМЕР: A22LS-01-0008 ВЕС: 2.84 кг</p>

	<p>NAME: Floor panel assembly, forward, painted PART NO.: A22LS-01-0009 WEIGHT: 2.95 kg</p>
	<p>НАИМЕН.: Панель пола в сборе, передняя, окрашенная НОМЕР: A22LS-01-0009 ВЕС: 2.95 кг</p>
	<p>NAME: Doubler, painted PART NO.: A22LS-01-0010 WEIGHT: 0.45 kg</p>
	<p>НАИМЕН.: Накладка, окрашенная НОМЕР: A22LS-01-0010 ВЕС: 0.45 кг</p>
	<p>NAME: Floor panel, rear, not painted PART NO.: A22LS-01-0011 WEIGHT: 1.3 kg</p>
	<p>НАИМЕН.: Панель пола, задняя, неокрашенная НОМЕР: A22LS-01-0011 ВЕС: 1.3 кг</p>
	<p>NAME: Tail wheel Ø150 mm PART NO.: A22LS-01-0012 WEIGHT: 0.15 kg</p>
	<p>НАИМЕН.: Хвостовое колесо Ø150 мм НОМЕР: A22LS-01-0012 ВЕС: 0.15 кг</p>



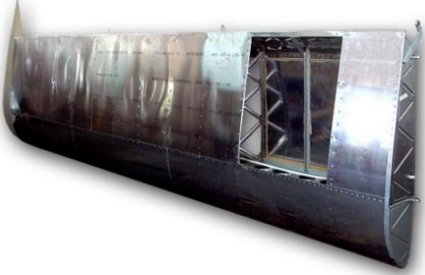
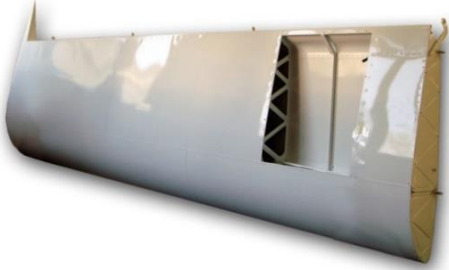
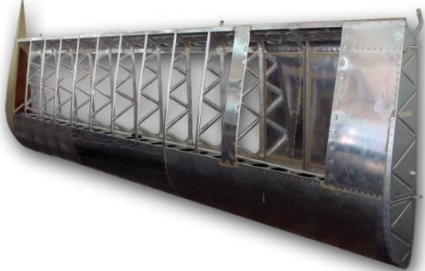
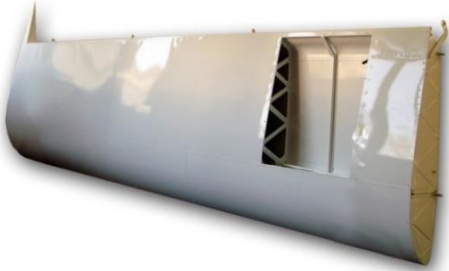

	NAME: Tail wheel Ø175 mm (towplane) PART NO.: A22LS-01-0013 WEIGHT: 0.19 kg
	НАИМЕН.: Хвостовое колесо Ø175 мм (буксировщик) НОМЕР: A22LS-01-0013 ВЕС: 0.19 кг

Wing / Крыло

	<p>NAME: Outer wing, not covered (only for A22LS and A22L2 with 525 kg MTOW) PART NO.: A22LS-01-1000 R A22LS-01-1000 L WEIGHT: 21.3 kg</p> <hr/> <p>НАИМЕН.: Консоль крыла, не обтянутая (только для A22LS и A22L2 с Мвзл 525 кг) НОМЕР: A22LS-01-1000 R A22LS-01-1000 L ВЕС: 21.3 кг</p>
	<p>NAME: Outer wing, painted (only for A22LS and A22L2 with 525 kg MTOW) PART NO.: A22LS-01-1001 R A22LS-01-1001 L WEIGHT: 23.5 kg</p> <hr/> <p>НАИМЕН.: Консоль крыла, окрашенная (только для A22LS и A22L2 с Мвзл 525 кг) НОМЕР: A22LS-01-1001 R A22LS-01-1001 L ВЕС: 23.5 кг</p>
	<p>NAME: Outer wing, not covered (A22L2 only) PART NO.: A22L2-01-1000 R A22L2-01-1000 L WEIGHT: 17.2 kg</p> <hr/> <p>НАИМЕН.: Консоль крыла, не обтянутая (только для A22L2) НОМЕР: A22L2-01-1000 R A22L2-01-1000 L ВЕС: 17.2 кг</p>
	<p>NAME: Outer wing, painted (A22L2 only) PART NO.: A22L2-01-1001 R A22L2-01-1001 L WEIGHT: 19.6 kg</p> <hr/> <p>НАИМЕН.: Консоль крыла, окрашенная (только для A22L2) НОМЕР: A22L2-01-1001 R A22L2-01-1001 L ВЕС: 19.6 кг</p>

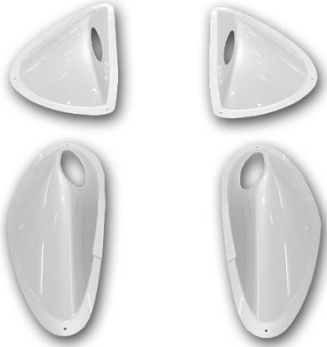

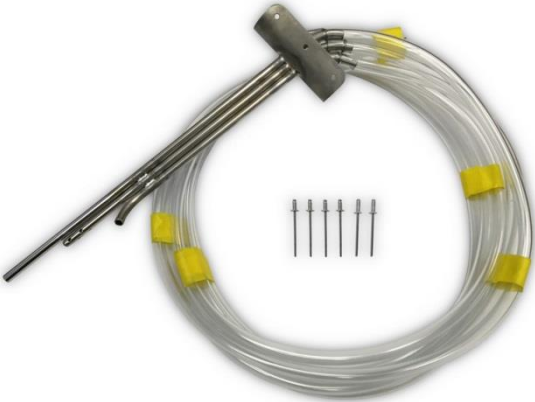
	<p>NAME: Flaperon hinge bracket bearings (a set) PART NO.: A22LS-01-1002 WEIGHT: 0.021 kg</p>
	<p>NAME: Flaperon, not covered PART NO.: A22LS-01-1003 R A22LS-01-1003 L WEIGHT: 3.4 kg</p>
	<p>NAME: Flaperon, painted PART NO.: A22LS-01-1004 R A22LS-01-1004 L WEIGHT: 4.1 kg</p>
	<p>NAME: Flaperon trim tab, not painted PART NO.: A22LS-01-1005 WEIGHT: 0.025 kg</p> <p>НАИМЕН.: Триммер флаперона, неокрашенный НОМЕР: A22LS-01-1005 ВЕС: 0.025 кг</p>

	<p>NAME: Flaperon trim tab, painted PART NO.: A22LS-01-1006 WEIGHT: 0.03 kg</p>
	<p>НАИМЕН.: Триммер флаперона, окрашенный НОМЕР: A22LS-01-1006 ВЕС: 0.03 кг</p>
	<p>NAME: Fuel tank 45 L, not painted PART NO.: A22LS-01-1007 R A22LS-01-1007 L WEIGHT: 3.19 kg</p>
	<p>НАИМЕН.: Бак топливный 45 л, неокрашенный НОМЕР: A22LS-01-1007 R A22LS-01-1007 L ВЕС: 3.19 кг</p>
	<p>NAME: Fuel tank cap PART NO.: A22LS-01-1008 WEIGHT: 0.075 kg</p>
	<p>НАИМЕН.: Крышка топливного бака НОМЕР: A22LS-01-1008 ВЕС: 0.075 кг</p>
	<p>NAME: Wing strut, painted PART NO.: A22LS-01-1009 R A22LS-01-1009 L WEIGHT: 3.6 kg</p>
	<p>НАИМЕН.: Подкос крыла, окрашенный НОМЕР: A22LS-01-1009 R A22LS-01-1009 L ВЕС: 3.6 кг</p>

	<p>NAME: Wing strut fairings, painted (a set) PART NO.: A22LS-01-1010 WEIGHT: 0.5 kg</p>
	<p>NAME: Pitot tube PART NO.: A22LS-01-1011 WEIGHT: 0.3 kg</p>
	<p>NAME: Pitot tube with angle attack sensor PART NO.: A22LS-01-1012 WEIGHT: 0.32 kg</p>
	<p>NAME: Wing covering, DIATEX fabric PART NO.: A22LS-01-1013 WEIGHT: 0.18 kg</p>
	<p>НАИМЕН.: Обтекатели подкосов, окрашенные (комплект) НОМЕР: A22LS-01-1010 ВЕС: 0.5 кг</p> <p>НАИМЕН.: Приемник воздушного давления НОМЕР: A22LS-01-1011 ВЕС: 0.3 кг</p> <p>НАИМЕН.: Приемник воздушного давления с датчиком угла атаки НОМЕР: A22LS-01-1012 ВЕС: 0.32 кг</p> <p>NAME: Wing covering, DIATEX fabric PART NO.: A22LS-01-1013 WEIGHT: 0.18 kg</p> <p>НАИМЕН.: Обшивка крыла (ткань DIATEX) НОМЕР: A22LS-01-1013 ВЕС: 0.18 кг</p>

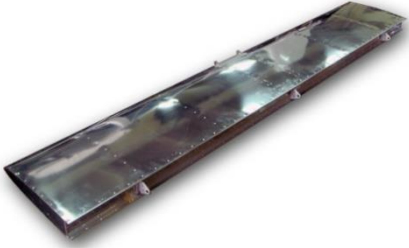

	<p>NAME: Wing covering, upper, DIATEX fabric, (A22L2 only) PART NO.: A22L2-01-1002 WEIGHT: 0.22 kg</p>
	<p>NAME: Flaperon covering, DIATEX fabric PART NO.: A22LS-01-1014 WEIGHT: 0.27 kg</p>
	<p>NAME: Tie-down rings PART NO.: A22LS-01-1015 WEIGHT: 0.1 kg</p> <p>НАИМЕН.: Швартовочные проушины НОМЕР: A22LS-01-1015 ВЕС: 0.1 кг</p>

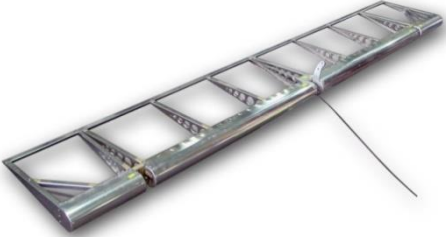
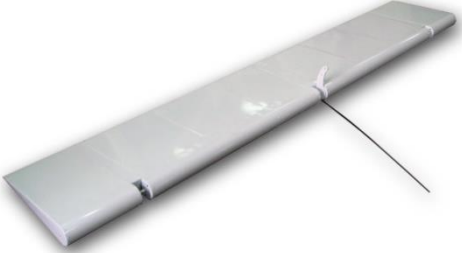
Horizontal empennage / Горизонтальное оперение

	<p>NAME: Stabilizer, not painted PART NO.: A22LS-01-2000 WEIGHT: 6.3 kg</p>
	<p>НАИМЕН.: Стабилизатор, неокрашенный НОМЕР: A22LS-01-2000 ВЕС: 6.3 кг</p>
	<p>NAME: Stabilizer, painted PART NO.: A22LS-01-2001 WEIGHT: 6.7 kg</p>
	<p>НАИМЕН.: Стабилизатор, окрашенный НОМЕР: A22LS-01-2001 ВЕС: 6.7 кг</p>
	<p>NAME: Elevator, not covered PART NO.: A22LS-01-2002 WEIGHT: 2.2 kg</p>
	<p>НАИМЕН.: Руль высоты, не обтянутый НОМЕР: A22LS-01-2002 ВЕС: 2.2 кг</p>
	<p>NAME: Elevator, painted PART NO.: A22LS-01-2003 WEIGHT: 2.8 kg</p>
	<p>НАИМЕН.: Руль высоты, окрашенный НОМЕР: A22LS-01-2003 ВЕС: 2.8 кг</p>

	NAME: Elevator trim tab, not painted PART NO.: A22LS-01-2004 WEIGHT: 0.2 kg
	НАИМЕН.: Триммер РВ, неокрашенный НОМЕР: A22LS-01-2004 ВЕС: 0.2 кг
	NAME: Elevator trim tab, painted PART NO.: A22LS-01-2005 WEIGHT: 0.23 kg
	НАИМЕН.: Триммер РВ, окрашенный НОМЕР: A22LS-01-2005 ВЕС: 0.23 кг
	NAME: Elevator covering (DIATEX fabric) PART NO.: A22LS-01-2006 WEIGHT: 0.2 kg
	НАИМЕН.: Обшивка руля высоты (ткань DIATEX) НОМЕР: A22LS-01-2006 ВЕС: 0.2 кг

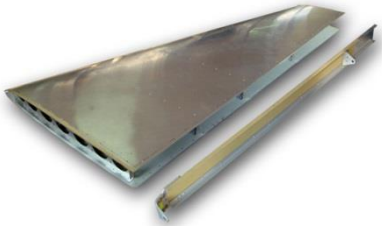
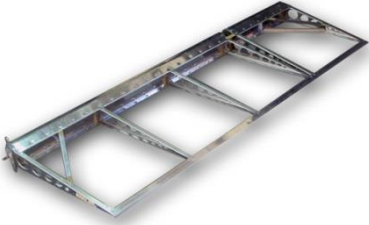



Vertical empennage / Вертикальное оперение

	<p>NAME: Fin and fin spar, not painted PART NO.: A22LS-01-3000 WEIGHT: 2.0 kg</p>
	<p>НАИМЕН.: Киль и лонжерон кия, неокрашенные НОМЕР: A22LS-01-3000 ВЕС: 2.0 кг</p>
	<p>NAME: Rudder, not covered PART NO.: A22LS-01-3001 WEIGHT: 1.1 kg</p>
	<p>НАИМЕН.: Руль направления, не обтянутый НОМЕР: A22LS-01-3001 ВЕС: 1.1 кг</p>
	<p>NAME: Rudder, painted PART NO.: A22LS-01-3002 WEIGHT: 1.4 kg</p>
	<p>НАИМЕН.: Руль направления, окрашенный НОМЕР: A22LS-01-3002 ВЕС: 1.4 кг</p>
	<p>NAME: Rudder covering (DIATEX fabric) PART NO.: A22LS-01-3003 WEIGHT: 0.13 kg</p>
	<p>НАИМЕН.: Обшивка руля направления (ткань DIATEX) НОМЕР: A22LS-01-3003 ВЕС: 0.13 кг</p>

Glass / Остекление





	<p>NAME: Acrylic windscreen glass PART NO.: A22LS-01-4000 WEIGHT: 3.2 kg</p>
	<p>НАИМЕН.: Акриловое лобовое стекло НОМЕР: A22LS-01-4000 ВЕС: 3.2 кг</p>
	<p>NAME: Windscreen glass edging, not painted PART NO.: A22LS-01-4001 WEIGHT: 0.45 kg</p>
	<p>НАИМЕН.: Панки лобового стекла, неокрашенные НОМЕР: A22LS-01-4001 ВЕС: 0.45 кг</p>
	<p>NAME: Rear glass edging, not painted PART NO.: A22LS-01-4002 WEIGHT: 0.28 kg</p>
	<p>НАИМЕН.: Панки заднего остекления, неокрашенные НОМЕР: A22LS-01-4002 ВЕС: 0.28 кг</p>

Doors / Двери

	<p>NAME: Door, painted PART NO.: A22LS-01-5000 R A22LS-01-5000 L WEIGHT: 3.7 kg</p>
	<p>НАИМЕН.: Дверь, окрашенная НОМЕР: A22LS-01-5000 R A22LS-01-5000 L ВЕС: 3.7 кг</p>
	<p>NAME: Door with big sliding window, painted PART NO.: A22LS-01-5001 R A22LS-01-5001 L WEIGHT: 4.5 kg</p>
	<p>НАИМЕН.: Дверь окрашенная с большой форточкой НОМЕР: A22LS-01-5001 R A22LS-01-5001 L ВЕС: 4.5 кг</p>
	<p>NAME: Door glass PART NO.: A22LS-01-5002 R A22LS-01-5002 L WEIGHT: 2.0 kg</p>
	<p>НАИМЕН.: Стекло двери НОМЕР: A22LS-01-5002 R A22LS-01-5002 L ВЕС: 2.0 кг</p>
	<p>NAME: Vent scoop PART NO.: A22LS-01-5003 WEIGHT: 0.02 kg</p>
	<p>НАИМЕН.: Форточка НОМЕР: A22LS-01-5003 ВЕС: 0.02 кг</p>

	NAME: Gas strut PART NO.: A22LS-01-5004 WEIGHT: 0.25 kg
	НАИМЕН.: Газовая пружина НОМЕР: A22LS-01-5004 ВЕС: 0.25 кг

02. LANDING GEAR / ШАССИ**Nose leg / Передняя стойка**



	<p>NAME: Nose landing gear leg 6x6, primed PART NO.: A22LS-02-0009 WEIGHT: 5.078 kg</p>
	<p>НАИМЕН.: Передняя стойка шасси 6x6, грунтованная НОМЕР: A22LS-02-0009 ВЕС: 5.078 кг</p>
	<p>NAME: Nose landing gear leg 6x6, painted PART NO.: A22LS-02-0001 WEIGHT: 5.093 kg</p>
	<p>НАИМЕН.: Передняя стойка шасси 6x6, окрашенная НОМЕР: A22LS-02-0001 ВЕС: 5.093 кг</p>
	<p>NAME: Nose landing gear leg 8x6, primed PART NO.: A22LS-02-0010 WEIGHT: 6.009 kg</p>
	<p>НАИМЕН.: Передняя стойка шасси 8x6, грунтованная НОМЕР: A22LS-02-0010 ВЕС: 6.009 кг</p>
	<p>NAME: Nose landing gear leg 8x6, painted PART NO.: A22LS-02-0011 WEIGHT: 6.024 kg</p>
	<p>НАИМЕН.: Передняя стойка шасси 8x6, окрашенная НОМЕР: A22LS-02-0011 ВЕС: 6.024 кг</p>

	<p>NAME: Nose wheel fork 6x6 PART NO.: A22LS-02-0002 WEIGHT: 2.304 kg</p>
	<p>НАИМЕН.: Вилка передней стойки 6x6 НОМЕР: A22LS-02-0002 ВЕС: 2.304 кг</p>
	<p>NAME: Nose wheel fork 8x6 PART NO.: A22LS-02-0013 WEIGHT: 3.179 kg</p>
	<p>НАИМЕН.: Вилка передней стойки 8x6 НОМЕР: A22LS-02-0013 ВЕС: 3.179 кг</p>
	<p>NAME: 6x6 Nose landing gear strut with bellcrank, primed PART NO A22LS-02-0016 WEIGHT: 2.253 kg</p>
	<p>НАИМЕН.: Рычаг передней стойки 6x6 с качалкой, грунтованный НОМЕР: A22LS-02-0016 ВЕС: 2.253 кг</p>
	<p>NAME: 6x6 Nose landing gear strut with bellcrank, painted PART NO A22LS-02-0003 WEIGHT: 2.268 kg</p>
	<p>НАИМЕН.: Рычаг передней стойки 6x6 с качалкой, окрашенный НОМЕР: A22LS-02-0003 ВЕС: 2.268 кг</p>



	<p>NAME: 8x6 Nose landing gear strut with bellcrank, primed PART NO A22LS-02-0017 WEIGHT: 2.194 kg</p>
	<p>NAME: 8x6 Nose landing gear strut with bellcrank, painted PART NO A22LS-02-0018 WEIGHT: 2.209 kg</p>
	<p>NAME: Spring shock absorber PART NO.: A22LS-02-0004 WEIGHT: 0.39 kg</p>
	<p>NAME: Nose landing gear strut support, upper PART NO.: A22LS-02-0005 WEIGHT: 0.23 kg</p>
	<p>НАИМЕН.: Рычаг передней стойки 8x6 с качалкой, грунтованный НОМЕР: A22LS-02-0017 ВЕС: 2.194 кг</p> <p>НАИМЕН.: Рычаг передней стойки 8x6 с качалкой, окрашенный НОМЕР: A22LS-02-0018 ВЕС: 2.209 кг</p> <p>НАИМЕН.: Пружинный амортизатор НОМЕР: A22LS-02-0004 ВЕС: 0.39 кг</p> <p>NAME: Nose landing gear strut support, upper PART NO.: A22LS-02-0005 WEIGHT: 0.23 kg</p> <p>НАИМЕН.: Опора передней стойки, верхняя НОМЕР: A22LS-02-0005 ВЕС: 0.23 кг</p>

	<p>NAME: Nose landing gear strut support assembly, lower PART NO.: A22LS-02-0006 WEIGHT: 0.697 kg</p>
	<p>НАИМЕН.: Опора передней стойки в сборе, нижняя НОМЕР: A22LS-02-0006 ВЕС: 0.697 кг</p>
	<p>NAME: Nose landing gear strut support, lower PART NO.: A22LS-02-0019 WEIGHT: 0.225 kg</p>
	<p>НАИМЕН.: Опора передней стойки, нижняя НОМЕР: A22LS-02-0019 ВЕС: 0.225 кг</p>

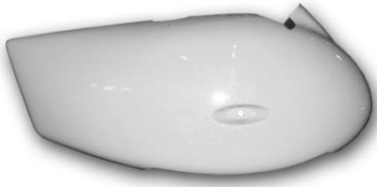

Main leg / Основная стойка

	<p>NAME: Main landing gear leg with 6x6(8x6) wheel axle, not painted PART NO.: A22LS-02-1001 WEIGHT: 3.851 kg</p>
	<p>НАИМЕН.: Основная стойка с осью 6x6(8x6), неокрашенная НОМЕР: A22LS-02-1001 ВЕС: 3.851 кг</p>
	<p>NAME: Main landing gear leg with 6x6(8x6) wheel axle, painted PART NO.: A22LS-02-1000 WEIGHT: 3.881 kg</p>
	<p>НАИМЕН.: Основная стойка в сборе 6x6(8x6), окрашенная НОМЕР: A22LS-02-1000 ВЕС: 3.881 кг</p>
	<p>NAME: Fasteners for installation of A22 main landing gear PART NO.: A22LS-02-1004 WEIGHT: 0.172 kg</p>
	<p>НАИМЕН.: Крепеж для установки основной стойки A22 НОМЕР: A22LS-02-1004 ВЕС: 0.172 кг</p>

Fairings / Обтекатели

	<p>NAME: Nose wheel fairing, not painted PART NO.: A22LS-02-2000 WEIGHT: 0.75 kg</p> <hr/> <p>НАИМЕН.: Обтекатель носового колеса, неокрашенный НОМЕР: A22LS-02-2000 ВЕС: 0.75 кг</p>
	<p>NAME: Nose wheel fairing, painted PART NO.: A22LS-02-2001 WEIGHT: 0.8 kg</p> <hr/> <p>НАИМЕН.: Обтекатель носового колеса, окрашенный НОМЕР: A22LS-02-2001 ВЕС: 0.8 кг</p>
	<p>NAME: Main wheel fairing, not painted PART NO.: A22LS-02-2002 R A22LS-02-2002 L WEIGHT: 0.65 kg</p> <hr/> <p>НАИМЕН.: Обтекатель основного колеса, не окрашенный НОМЕР: A22LS-02-2002 R A22LS-02-2002 L ВЕС: 0.65 кг</p>
	<p>NAME: Main wheel fairing, painted PART NO.: A22LS-02-2003 R A22LS-02-2003 L WEIGHT: 0.7 kg</p> <hr/> <p>НАИМЕН.: Обтекатель основного колеса, окрашенный НОМЕР: A22LS-02-2003 R A22LS-02-2003 L ВЕС: 0.7 кг</p>

Mud-screens / Щитки

	<p>NAME: Cheng shin 6x6 nose wheel mud-screen PART NO A22LS-02-3000 WEIGHT: 0.276 kg</p> <hr/> <p>НАИМЕН.: Щиток носового колеса 6x6 Cheng shin НОМЕР: A22LS-02-3000 ВЕС: 0.276 кг</p>
	<p>NAME: Airtrac 6x6 nose wheel mud-screen PART NO A22LS-02-3002 WEIGHT: 0.266 kg</p> <hr/> <p>НАИМЕН.: Щиток носового колеса 6x6 Airtrac НОМЕР: A22LS-02-3002 ВЕС: 0.266 кг</p>
	<p>NAME: Carlisle-Tyre 8x6 nose wheel mud-screen PART NO A22LS-02-3003 WEIGHT: 0.382 kg</p> <hr/> <p>НАИМЕН.: Щиток носового колеса 8x6 Carlisle-Tyre НОМЕР: A22LS-02-3003 ВЕС: 0.382 кг</p>
	<p>NAME: Cheng shin 6x6 main wheel mud-screen PART NO.: A22LS-02-3001 R A22LS-02-3001 L WEIGHT: 0.433 kg</p> <hr/> <p>НАИМЕН.: Щиток основного колеса 6x6 Cheng shin НОМЕР: A22LS-02-3001 R A22LS-02-3001 L ВЕС: 0.433 кг</p>

 The image shows the Airtrac 6x6 main wheel mud-screen assembly. It consists of a curved metal bracket with a mounting flange at one end, a semi-circular mud-screen plate, and four screws with washers used for attachment.	<p>NAME: Airtrac 6x6 main wheel mud-screen PART NO.: A22LS-02-3004 R A22LS-02-3004 L WEIGHT: 0.433 kg</p>
 The image shows the Carlisle-Tyre 8x6 main wheel mud-screen assembly. It consists of a curved metal bracket with a mounting flange at one end, a semi-circular mud-screen plate, and four screws with washers used for attachment.	<p>NAME: Carlisle-Tyre 8x6 main wheel mud-screen PART NO.: A22LS-02-3005 R A22LS-02-3005 L WEIGHT: 0.548 kg</p> <p>НАИМЕН.: Щиток основного колеса 6x6 Airtrac НОМЕР: A22LS-02-3004 R A22LS-02-3004 L ВЕС: 0.433 кг</p> <p>НАИМЕН.: Щиток основного колеса 8x6 Carlisle-Tyre НОМЕР: A22LS-02-3005 R A22LS-02-3005 L ВЕС: 0.548 кг</p>

Wheels / Колеса

	<p>NAME: Cheng shin 6x6 tyre and tube PART NO.: A22LS-02-4001 WEIGHT: 2.662 kg</p>
	<p>НАИМЕН.: Шина Cheng shin 6x6 и камера НОМЕР: A22LS-02-4001 ВЕС: 2.662 кг</p>
	<p>NAME: Airtrac 6x6 tyre and tube PART NO.: A22LS-02-4002 WEIGHT: 3.138 kg</p>
	<p>НАИМЕН.: Шина Airtrac 6x6 и камера НОМЕР: A22LS-02-4002 ВЕС: 3.138 кг</p>
	<p>NAME: Carlisle-Tyre 8x6 tyre and tube PART NO.: A22LS-02-4003 WEIGHT: 4.223 kg</p>
	<p>НАИМЕН.: Шина Carlisle-Tyre 8x6 и камера НОМЕР: A22LS-02-4003 ВЕС: 4.223 кг</p>
	<p>NAME: Nose wheel PART NO.: A22LS-02-4004 WEIGHT: 1.2 kg</p>
	<p>НАИМЕН.: Носовое колесо НОМЕР: A22LS-02-4004 ВЕС: 1.2 кг</p>

	<p>NAME: Wheel with brake PART NO.: A22LS-02-4005 WEIGHT: 1.621 kg</p>
	<p>НАИМЕН.: Тормозное колесо НОМЕР: A22LS-02-4005 ВЕС: 1.621 кг</p>
	<p>NAME: Brake disk PART NO.: A22LS-02-4006 WEIGHT: 0.393 kg</p>
	<p>НАИМЕН.: Тормозной диск НОМЕР: A22LS-02-4006 ВЕС: 0.393 кг</p>

Brakes / Тормоза

	<p>NAME: Master brake cylinder (yoke) PART NO.: A22LS-02-5000 WEIGHT: 0.2 kg</p>
	<p>NAME: Master brake cylinder (stick) PART NO.: A22LS-02-5004 WEIGHT: 0.2 kg</p>
	<p>NAME: Brake system fittings (yoke, a set) PART NO.: A22LS-02-5005 WEIGHT: 0.117 kg</p>
	<p>NAME: Brake system fittings (stick, a set) PART NO.: A22LS-02-5001 WEIGHT: 0.132 kg</p>
	<p>НАИМЕН.: Главный тормозной цилиндр (штурвал) НОМЕР: A22LS-02-5000 ВЕС: 0.2 кг</p> <p>НАИМЕН.: Главный тормозной цилиндр (ручка) НОМЕР: A22LS-02-5004 ВЕС: 0.2 кг</p> <p>НАИМЕН.: Фитинги тормозной системы (штурвал, комплект) НОМЕР: A22LS-02-5005 ВЕС: 0.117 кг</p> <p>НАИМЕН.: Фитинги тормозной системы (ручка, комплект) НОМЕР: A22LS-02-5001 ВЕС: 0.132 кг</p>

	<p>NAME: Braking system tubing (a set) PART NO.: A22LS-02-5002 WEIGHT: 0.25 kg</p>
	<p>НАИМЕН.: Трубка тормозной системы (комплект) НОМЕР: A22LS-02-5002 ВЕС: 0.25 кг</p>
	<p>NAME: Braking system expansion tank PART NO.: A22LS-02-5003 WEIGHT: 0.04 kg</p>
	<p>НАИМЕН.: Тормозной расширительный бачок НОМЕР: A22LS-02-5003 ВЕС: 0.04 кг</p>
	<p>NAME: SwiftLine Kit for WHLB3 Brakes PART NO.: A22LS-02-5006 WEIGHT: 0.382 kg</p>
	<p>НАИМЕН.: Комплект тормозных колодок в сборе WHLB3 НОМЕР: A22LS-02-5006 ВЕС: 0.382 кг</p>

03. ENGINE AND ITS SYSTEMS / ДВИГАТЕЛЬ И ЕГО СИСТЕМЫ

Engine mount / Моторама

	<p>NAME: Engine mount (a set) PART NO.: A22LS-03-0001 WEIGHT: 5.1 kg</p>
	<p>НАИМЕН.: Моторама (комплект) НОМЕР: A22LS-03-0001 ВЕС: 5.1 кг</p> <p>NAME: Rubber shock absorbers (aircraft kit). Valid up to A22LS s/n 438, A22L2 s/n 605 inclusive PART NO.: A22LS-03-0002 WEIGHT: 0.468 kg</p>
	<p>НАИМЕН.: Резиновые амортизаторы (комплект на самолет). Действует до A22LS s/n 438, A22L2 s/n 605 включительно НОМЕР: A22LS-03-0002 ВЕС: 0.468 кг</p> <p>NAME: Rubber shock absorbers (aircraft kit). Valid from A22LS s/n 439, A22L2 s/n 606 inclusive PART NO.: A22LS-03-0003 WEIGHT: 0.501 kg</p> <p>НАИМЕН.: Резиновые амортизаторы (комплект на самолет). Действует с A22LS s/n 439, A22L2 s/n 606 включительно НОМЕР: A22LS-03-0003 ВЕС: 0.501 кг</p>

Control system / Система управления

	<p>NAME: Carburettor heating (a set) PART NO.: A22LS-03-1000 WEIGHT: 0.58 kg</p> <hr/> <p>НАИМЕН.: Обогрев карбюраторов (комплект) НОМЕР: A22LS-03-1000 ВЕС: 0.58 кг</p>
	<p>NAME: Sealing ring PART NO.: A22LS-03-1001 WEIGHT: 0.005 kg</p> <hr/> <p>НАИМЕН.: Уплотнительное кольцо НОМЕР: A22LS-03-1001 ВЕС: 0.005 кг</p>
	<p>NAME: US/ULS throttle lever Bowden cable housing, right (stick) PART NO.: A22LS-03-1002 WEIGHT: 0.107 kg</p> <hr/> <p>НАИМЕН.: Боуден РУДа US(ULS) правый (ручка) НОМЕР: A22LS-03-1002 ВЕС: 0.107 кг</p>
	<p>NAME: US/ULS throttle lever Bowden cable housing, left (stick) PART NO.: A22LS-03-1003 WEIGHT: 0.076 kg</p> <hr/> <p>НАИМЕН.: Боуден РУДа US(ULS) левый (ручка) НОМЕР: A22LS-03-1003 ВЕС: 0.076 кг</p>

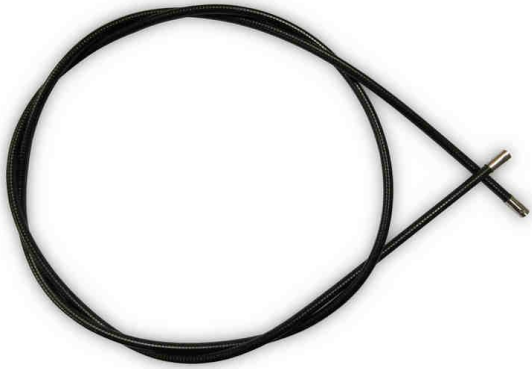
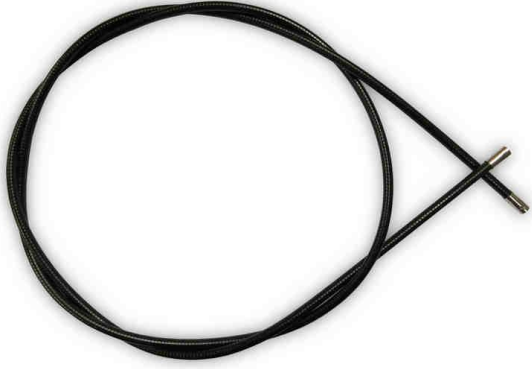
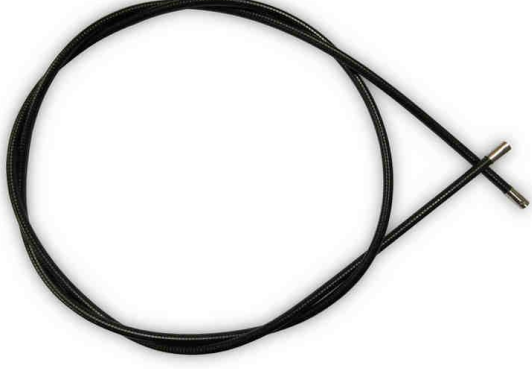
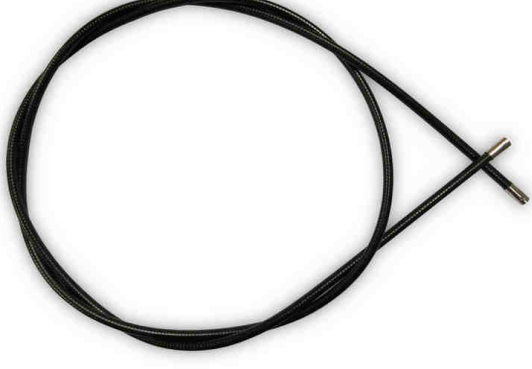
	<p>NAME: iS throttle lever Bowden cable housing (stick) PART NO.: A22LS-03-1004 WEIGHT: 0.098 kg</p>
	<p>НАИМЕН.: Боуден РУДа iS (ручка) НОМЕР: A22LS-03-1004 ВЕС: 0.098 кг</p>
	<p>NAME: US/ULS throttle lever Bowden cable housing, right (yoke) PART NO.: A22LS-03-1005 WEIGHT: 0.082 kg</p>
	<p>НАИМЕН.: Боуден РУДа US(ULS) правый (штурвал) НОМЕР: A22LS-03-1005 ВЕС: 0.082 кг</p>
	<p>NAME: US/ULS throttle lever Bowden cable housing, left (yoke) PART NO.: A22LS-03-1006 WEIGHT: 0.076 kg</p>
	<p>НАИМЕН.: Боуден РУДа US(ULS) левый (штурвал) НОМЕР: A22LS-03-1006 ВЕС: 0.076 кг</p>
	<p>NAME: iS throttle lever Bowden cable housing (yoke) PART NO.: A22LS-03-1007 WEIGHT: 0.091 kg</p>
	<p>НАИМЕН.: Боуден РУДа iS (штурвал) НОМЕР: A22LS-03-1007 ВЕС: 0.091 кг</p>

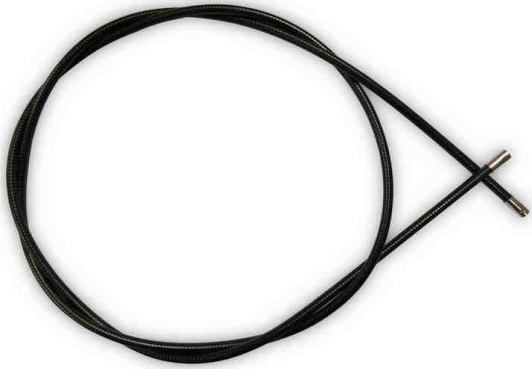
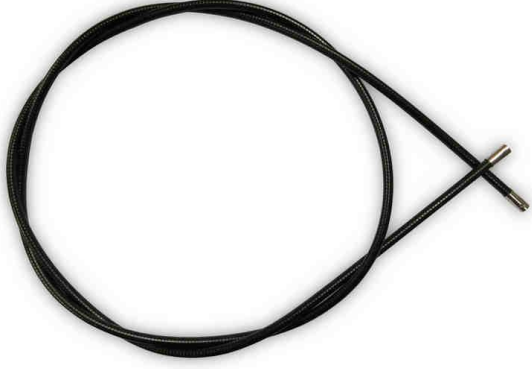
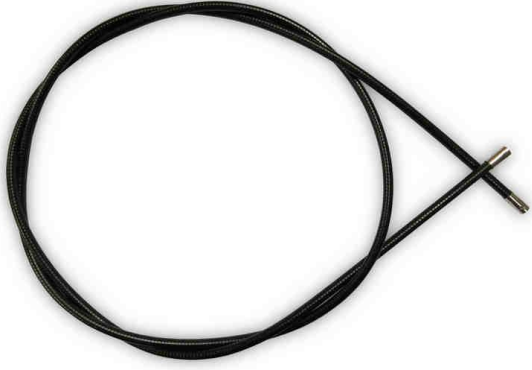
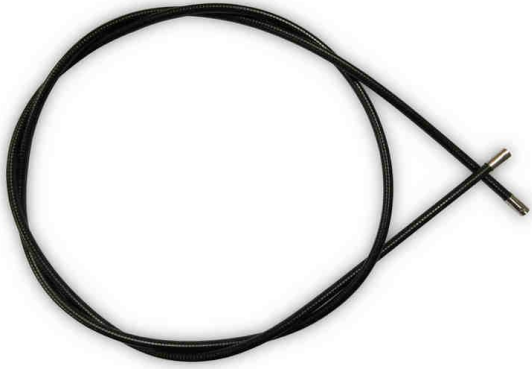
	<p>NAME: Choke Bowden cable housing, right (stick) PART NO.: A22LS-03-1008 WEIGHT: 0.067 kg</p>
	<p>NAME: Choke Bowden cable housing, left (stick) PART NO.: A22LS-03-1009 WEIGHT: 0.069 kg</p>
	<p>NAME: Choke Bowden cable housing, right (yoke) PART NO.: A22LS-03-1010 WEIGHT: 0.079 kg</p>
	<p>NAME: Choke Bowden cable housing, left (yoke) PART NO.: A22LS-03-1011 WEIGHT: 0.074 kg</p>

	<p>NAME: US/ULS throttle lever Bowden cable inner wire, right (stick) PART NO.: A22LS-03-1012 WEIGHT: 0.023 kg</p>
	<p>НАИМЕН.: Трос РУДа US(ULS) правый (ручка) НОМЕР: A22LS-03-1012 ВЕС: 0.023 кг</p>
	<p>NAME: US/ULS throttle lever Bowden cable inner wire, left (stick) PART NO.: A22LS-03-1013 WEIGHT: 0.018 kg</p>
	<p>НАИМЕН.: Трос РУДа US(ULS) левый (ручка) НОМЕР: A22LS-03-1013 ВЕС: 0.018 кг</p>
	<p>NAME: iS throttle lever Bowden cable inner wire (stick) PART NO.: A22LS-03-1014 WEIGHT: 0.021 kg</p>
	<p>НАИМЕН.: Трос РУДа iS (ручка) НОМЕР: A22LS-03-1014 ВЕС: 0.021 кг</p>
	<p>NAME: US/ULS throttle lever Bowden cable inner wire, right (yoke) PART NO.: A22LS-03-1015 WEIGHT: 0.020 kg</p>
	<p>НАИМЕН.: Трос РУДа US(ULS) правый (штурвал) НОМЕР: A22LS-03-1015 ВЕС: 0.020 кг</p>

	<p>NAME: US/ULS throttle lever Bowden cable inner wire, left (yoke) PART NO.: A22LS-03-1016 WEIGHT: 0.019 kg</p>
	<p>НАИМЕН.: Трос РУДа US(ULS) левый (штурвал) НОМЕР: A22LS-03-1016 ВЕС: 0.019 кг</p>
	<p>NAME: iS throttle lever Bowden cable inner wire (yoke) PART NO.: A22LS-03-1017 WEIGHT: 0.021 kg</p>
	<p>НАИМЕН.: Трос РУДа iS (штурвал) НОМЕР: A22LS-03-1017 ВЕС: 0.021 кг</p>
	<p>NAME: Choke Bowden cable inner wire, right (stick) PART NO.: A22LS-03-1018 WEIGHT: 0.016 kg</p>
	<p>НАИМЕН.: Трос обогатителя правый (ручка) НОМЕР: A22LS-03-1018 ВЕС: 0.016 кг</p>
	<p>NAME: Choke Bowden cable inner wire, left (stick) PART NO.: A22LS-03-1019 WEIGHT: 0.016 kg</p>
	<p>НАИМЕН.: Трос обогатителя левый (ручка) НОМЕР: A22LS-03-1019 ВЕС: 0.016 кг</p>

	<p>NAME: Choke Bowden cable inner wire, right (yoke) PART NO.: A22LS-03-1020 WEIGHT: 0.018 kg</p>
	<p>НАИМЕН.: Трос обогатителя правый (штурвал) НОМЕР: A22LS-03-1020 ВЕС: 0.018 кг</p>
	<p>NAME: Choke Bowden cable inner wire, left (yoke) PART NO.: A22LS-03-1021 WEIGHT: 0.017 kg</p>
	<p>НАИМЕН.: Трос обогатителя левый (штурвал) НОМЕР: A22LS-03-1021 ВЕС: 0.017 кг</p>

Fuel system / Топливная система

	<p>NAME: Sediment container PART NO.: A22LS-03-2000 WEIGHT: 0.084 kg</p>
	<p>НАИМЕН.: Отстойник НОМЕР: A22LS-03-2000 ВЕС: 0.084 кг</p>
	<p>NAME: Fuel filter PART NO.: A22LS-03-2001 WEIGHT: 0.01 kg</p>
	<p>НАИМЕН.: Топливный фильтр НОМЕР: A22LS-03-2001 ВЕС: 0.01 кг</p>
 <p>IMAGE COMING SOON</p>	<p>NAME: 5-year rubber parts replacement kit (aircraft without oil thermostat). Without ROTAX parts. PART NO.: A22LS-03-2002 WEIGHT: 2.286 kg</p>
	<p>НАИМЕН.: Комплект для замены резиновых частей по 5-ти летнему сроку (самолет без маслотермостата). Без частей ROTAX. НОМЕР: A22LS-03-2002 ВЕС: 2.286 кг</p>
 <p>IMAGE COMING SOON</p>	<p>NAME: 5-year rubber parts replacement kit (aircraft with oil thermostat). Without ROTAX parts. PART NO.: A22LS-03-2003 WEIGHT: 2.593 kg</p>
	<p>НАИМЕН.: Комплект для замены резиновых частей по 5-ти летнему сроку (самолет с маслотермостатом). Без частей ROTAX. НОМЕР: A22LS-03-2003 ВЕС: 2.593 кг</p>





Oil system / Маслосистема





 IMAGE COMING SOON	NAME: Hoses and fittings of oil system without oil thermostat PART NO.: A22LS-03-3001 WEIGHT: 0.603 kg
	НАИМЕН.: Шланги и фитинги маслосистемы без маслотермостата НОМЕР: A22LS-03-3001 ВЕС: 0.603 кг
 IMAGE COMING SOON	NAME: Hoses and fittings of oil system with oil thermostat PART NO.: A22LS-03-3002 WEIGHT: 0.858 kg
	НАИМЕН.: Шланги и фитинги маслосистемы с маслотермостатом НОМЕР: A22LS-03-3002 ВЕС: 0.858 кг

Cooling system / Система охлаждения

	<p>NAME: Cooling system hoses (a set) PART NO.: A22LS-03-4000 WEIGHT: 0.872 kg</p> <hr/> <p>НАИМЕН.: Патрубки системы охлаждения (комплект) НОМЕР: A22LS-03-4000 ВЕС: 0.872 кг</p>
	<p>NAME: Water radiator clamps (a set) PART NO.: A22LS-03-4001 WEIGHT: 0.11 kg</p> <hr/> <p>НАИМЕН.: Хомуты водяного радиатора (комплект) НОМЕР: A22LS-03-4001 ВЕС: 0.11 кг</p>

Exhaust system / Выхлопная система

	<p>NAME: Exhaust system (a set, pipes without holes and EGT sensor fittings) PART NO.: A22LS-03-5000 WEIGHT: 4.24 kg</p> <p>НАИМЕН.: Выхлопная система (комплект, патрубки без отв., без резьбовых втулок под датчики температуры выхлопных газов) НОМЕР: A22LS-03-5000 ВЕС: 4.24 кг</p>
	<p>NAME: Exhaust muffler assembly PART NO.: A22LS-03-5001 WEIGHT: 2.55 kg</p> <p>НАИМЕН.: Глушитель в сборе НОМЕР: A22LS-03-5001 ВЕС: 2.55 кг</p>
	<p>NAME: Exhaust pipe of cyl. 1 (without holes and EGT sensor fittings) PART NO.: A22LS-03-5002 WEIGHT: 0.47 kg</p> <p>НАИМЕН.: Выхлопной патрубок 1 цили. (без отв., без резьбовых втулок под датчики температуры выхлопных газов) НОМЕР: A22LS-03-5002 ВЕС: 0.47 кг</p>
	<p>NAME: Exhaust pipe of cyl. 2 (without holes and EGT sensor fittings) PART NO.: A22LS-03-5003 WEIGHT: 0.49 kg</p> <p>НАИМЕН.: Выхлопной патрубок 2 цили. (без отв., без резьбовых втулок под датчики температуры выхлопных газов) НОМЕР: A22LS-03-5003 ВЕС: 0.49 кг</p>

	<p>NAME: Exhaust pipe of cyl. 3 (without holes and EGT sensor fittings) PART NO.: A22LS-03-5004 WEIGHT: 0.35 kg</p>
	<p>NAME: Exhaust pipe of cyl. 4 (without holes and EGT sensor fittings) PART NO.: A22LS-03-5005 WEIGHT: 0.37 kg</p>
	<p>NAME: Exhaust system springs (a set) PART NO.: A22LS-03-5006 WEIGHT: 0.17 kg</p>
	<p>NAME: EGT sensor fittings, M8x1 inner thread (a set) PART NO.: A22LS-03-5007 WEIGHT: 0.05 kg</p>
	<p>НАИМЕН.: Выхлопной патрубок 3 цили. (без отв., без резьбовых втулок под датчики температуры выхлопных газов) НОМЕР: A22LS-03-5004 ВЕС: 0.35 кг</p> <p>НАИМЕН.: Выхлопной патрубок 4 цили. (без отв., без резьбовых втулок под датчики температуры выхлопных газов) НОМЕР: A22LS-03-5005 ВЕС: 0.37 кг</p> <p>НАИМЕН.: Пружины выхлопной системы (комплект) НОМЕР: A22LS-03-5006 ВЕС: 0.17 кг</p> <p>НАИМЕН.: Втулки под датчики EGT, внутренняя резьба M8x1 (комплект) НОМЕР: A22LS-03-5007 ВЕС: 0.05 кг</p>

04. PROPELLER / ВОЗДУШНЫЙ ВИНТ**Spinner / Кок**

 A photograph showing the propeller spinner assembly. It includes a white, egg-shaped spinner cap, a circular metal base plate with four mounting tabs, and a small metal fastener.	<p>NAME: Propeller spinner, painted (a set) PART NO.: A22LS-04-0001 WEIGHT: 0.515 kg</p> <hr/> <p>НАИМЕН.: Кок винта, окрашенный (комплект) НОМЕР: A22LS-04-0001 ВЕС: 0.515 кг</p>
 A photograph showing the parts set for installation. It features a large circular metal plate with a central hole and eight smaller holes around the perimeter, and a small pile of yellowish metal washers.	<p>NAME: Parts set for installation of KievProp 283/1800 with spinner PART NO.: A22LS-04-0002 WEIGHT: 0.085 kg</p> <hr/> <p>НАИМЕН.: Комплект для установки воздушного винта КиевПроп 283/1800 с коком НОМЕР: A22LS-04-0002 ВЕС: 0.085 кг</p>

Propeller / Винт

	<p>NAME: KIEVPROP propeller 263/1700 (a set) PART NO.: A22LS-04-1000 WEIGHT: 4.068 kg</p>
	<p>НАИМЕН.: Воздушный винт КиевПроп 263/1700 (комплект) НОМЕР: A22LS-04-1000 ВЕС: 4.068 кг</p>
	<p>NAME: KIEVPROP propeller 283/1800 (a set) PART NO.: A22LS-04-1001 WEIGHT: 4.329 kg</p>
	<p>НАИМЕН.: Воздушный винт КиевПроп 283/1800 (комплект) НОМЕР: A22LS-04-1001 ВЕС: 4.329 кг</p>

05. AIRPLANE CONTROL SYSTEM / СИСТЕМА УПРАВЛЕНИЯ САМОЛЕТОМ

Control system levers / Посты системы управления

	<p>NAME: I(Y)-stick column cover PART NO.: A22LS-05-0003 WEIGHT: 0.083 kg</p>
	<p>НАИМЕН.: Чехол колонки I(Y)-ручки НОМЕР: A22LS-05-0003 ВЕС: 0.083 кг</p>
	<p>NAME: Stick column stop PART NO.: A22LS-05-0004 WEIGHT: 0.219 kg</p>
	<p>НАИМЕН.: Фиксатор колонки ручки НОМЕР: A22LS-05-0004 ВЕС: 0.219 кг</p>
	<p>NAME: Yoke support, right PART NO.: A22LS-05-0009 WEIGHT: 0.021 kg</p>
	<p>НАИМЕН.: Опора штурвала правая НОМЕР: A22LS-05-0009 ВЕС: 0.021 кг</p>
	<p>NAME: Yoke support, left PART NO.: A22LS-05-0010 WEIGHT: 0.015 kg</p>
	<p>НАИМЕН.: Опора штурвала левая НОМЕР: A22LS-05-0010 ВЕС: 0.015 кг</p>

	<p>NAME: Yoke neutral stop PART NO.: A22LS-05-0011 WEIGHT: 0.021 kg</p>
	<p>НАИМЕН.: Фиксатор нейтралі штурвалов НОМЕР: A22LS-05-0011 ВЕС: 0.021 кг</p>
	<p>NAME: Handle (1pc.) for I-stick, yoke, flap lever PART NO.: A22LS-05-0012 WEIGHT: 0.009 kg</p>
	<p>НАИМЕН.: Рукоятка (1шт.) для I-ручки, штурвалов, рычага закрылков НОМЕР: A22LS-05-0012 ВЕС: 0.009 кг</p>
	<p>NAME: A22LS (A22L2) Y-stick handles (shaped, 2 pcs.) PART NO.: A22LS-05-0013 WEIGHT: 0.027 kg</p>
	<p>НАИМЕН.: Рукоятки Y-ручки A22LS (A22L2) (фигурные 2шт.) НОМЕР: A22LS-05-0013 ВЕС: 0.027 кг</p>
	<p>NAME: Ø16x17 handle for control levers of trim tab, choke, parking brake PART NO.: A22LS-05-0014 WEIGHT: 0.003 kg</p>
	<p>НАИМЕН.: Рукоятка Ø16x17 рычагов триммера, обогатителя, стояночного тормоза НОМЕР: A22LS-05-0014 ВЕС: 0.003 кг</p>

	<p>NAME: Ø30x64 handle for throttle lever (yoke) PART NO.: A22LS-05-0015 WEIGHT: 0.035 kg</p>
	<p>НАИМЕН.: Рукоятка Ø30x64 рычага управления двигателем (штурвал) НОМЕР: A22LS-05-0015 ВЕС: 0.035 кг</p>
	<p>NAME: Ø22x25 handle for throttle lever (stick) PART NO.: A22LS-05-0016 WEIGHT: 0.008 kg</p>
	<p>НАИМЕН.: Рукоятка Ø22x25 рычага управления двигателем (ручка) НОМЕР: A22LS-05-0016 ВЕС: 0.008 кг</p>
	<p>NAME: Ø22x45 handle for brake lever (yoke) PART NO.: A22LS-05-0017 WEIGHT: 0.011 kg</p>
	<p>НАИМЕН.: Рукоятка Ø22x45 рычага тормоза (штурвал) НОМЕР: A22LS-05-0017 ВЕС: 0.011 кг</p>

Aileron control system / Система управления элеронами



	<p>NAME: Pushrod horizontal L=530 mm with spacers (set) PART NO.: A22LS-05-1000 WEIGHT: 0.19 kg</p>
	<p>НАИМЕН.: Тяга горизонтальная L=530 мм с распорными втулками (комплект) НОМЕР: A22LS-05-1000 ВЕС: 0.19 кг</p>
	<p>NAME: Diagonal rod L=553 mm PART NO.: A22LS-05-1001 WEIGHT: 0.25 kg</p>
	<p>НАИМЕН.: Тяга косая L=553 мм НОМЕР: A22LS-05-1001 ВЕС: 0.25 кг</p>
	<p>NAME: Torque shaft (yokes) PART NO.: A22LS-05-1002 WEIGHT: 0.87 kg</p>
	<p>НАИМЕН.: Вал крена (штурвал) НОМЕР: A22LS-05-1002 ВЕС: 0.87 кг</p>
	<p>NAME: Torque shaft (stick) PART NO.: A22LS-05-1003 WEIGHT: 0.55 kg</p>
	<p>НАИМЕН.: Вал крена (ручка) НОМЕР: A22LS-05-1003 ВЕС: 0.55 кг</p>



	<p>NAME: Torque shaft rocker, rear PART NO.: A22LS-05-1004 WEIGHT: 0.122 kg</p>
	<p>НАИМЕН.: Качалка вала крена, задняя НОМЕР: A22LS-05-1004 ВЕС: 0.122 кг</p>
	<p>NAME: Torque shaft pin with fasteners PART NO.: A22LS-05-1005 WEIGHT: 0.021 kg</p>
	<p>НАИМЕН.: Штифт вала крена с крепежом НОМЕР: A22LS-05-1005 ВЕС: 0.021 кг</p>
	<p>NAME: Vertical rod L=933 mm PART NO.: A22LS-05-1006 WEIGHT: 0.35 kg</p>
	<p>НАИМЕН.: Вертикальная тяга L=933 мм НОМЕР: A22LS-05-1006 ВЕС: 0.35 кг</p>
	<p>NAME: Flaperon shaft PART NO.: A22LS-05-1007 R A22LS-05-1007 L WEIGHT: 0.496 kg</p>
	<p>НАИМЕН.: Вал флаперона НОМЕР: A22LS-05-1007 R A22LS-05-1007 L ВЕС: 0.496 кг</p>

	<p>NAME: Universal joint ring PART NO.: A22LS-05-1008 WEIGHT: 0.07 kg</p>
	<p>NAME: Flap extension lever PART NO.: A22LS-05-1009 WEIGHT: 0.506 kg</p>
	<p>NAME: Flap extension mechanism rocker PART NO.: A22LS-05-1010 WEIGHT: 0.221 kg</p>
	<p>NAME: Flap extension mechanism shackle PART NO.: A22LS-05-1011 WEIGHT: 0.091 kg</p>
	<p>НАИМЕН.: Кольцо карданное НОМЕР: A22LS-05-1008 ВЕС: 0.07 кг</p> <p>НАИМЕН.: Рычаг механизма выпуска закрылков НОМЕР: A22LS-05-1009 ВЕС: 0.506 кг</p> <p>НАИМЕН.: Коромысло механизма выпуска закрылков НОМЕР: A22LS-05-1010 ВЕС: 0.221 кг</p> <p>НАИМЕН.: Серьга механизма выпуска закрылков НОМЕР: A22LS-05-1011 ВЕС: 0.091 кг</p>

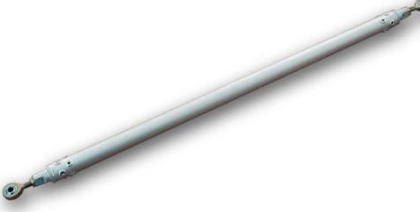
	<p>NAME: Flap extension mechanism cover, not painted PART NO.: A22LS-05-1012 WEIGHT: 0.197 kg</p>
	<p>НАИМЕН.: Крышка механизма выпуска закрылков, неокрашенная НОМЕР: A22LS-05-1012 ВЕС: 0.197 кг</p>
	<p>NAME: Flap extension mechanism cover, painted PART NO.: A22LS-05-1013 WEIGHT: 0.210 kg</p>
	<p>НАИМЕН.: Крышка механизма выпуска закрылков, окрашенная НОМЕР: A22LS-05-1013 ВЕС: 0.210 кг</p>
	<p>NAME: Flap extension lever stop PART NO.: A22LS-05-1014 WEIGHT: 0.078 kg</p>
	<p>НАИМЕН.: Фиксатор рычага закрылков НОМЕР: A22LS-05-1014 ВЕС: 0.078 кг</p>
	<p>NAME: Flap extension lever stop sleeve PART NO.: A22LS-05-1015 WEIGHT: 0.010 kg</p>
	<p>НАИМЕН.: Втулка фиксатора НОМЕР: A22LS-05-1015 ВЕС: 0.010 кг</p>

Elevator control system / Система управления РВ

	<p>NAME: Elevator rod 1 (yokes) L=1002 mm PART NO.: A22LS-05-2000 WEIGHT: 0.37 kg</p>
	<p>НАИМЕН.: Тяга руля высоты 1 (штурвал), L=1002 мм НОМЕР: A22LS-05-2000 ВЕС: 0.37 кг</p>
	<p>NAME: Elevator rod 1 (stick) L=545 mm PART NO.: A22LS-05-2001 WEIGHT: 0.19 kg</p>
	<p>НАИМЕН.: Тяга руля высоты 1 (ручка) L=545 мм НОМЕР: A22LS-05-2001 ВЕС: 0.19 кг</p>
	<p>NAME: Elevator rod 2 L=1502 mm PART NO A22LS-05-2002 WEIGHT: 0.6 kg</p>
	<p>НАИМЕН.: Тяга руля высоты 2 L=1502 мм НОМЕР: A22LS-05-2002 ВЕС: 0.6 кг</p>
	<p>NAME: Elevator rod 3 L=2155 mm PART NO.: A22LS-05-2003 WEIGHT: 0.74 kg</p>
	<p>НАИМЕН.: Тяга руля высоты 3 L=2155 мм НОМЕР: A22LS-05-2003 ВЕС: 0.74 кг</p>

	<p>NAME: Forward rocker of elevator control system PART NO.: A22LS-05-2004 WEIGHT: 0.077 kg</p>
	<p>NAME: Rear rocker of elevator control system PART NO.: A22LS-05-2005 WEIGHT: 0.078 kg</p>
	<p>NAME: Supporting rollers PART NO.: A22LS-05-2006 WEIGHT: 0.081 kg</p>
	<p>NAME: Relief spring PART NO.: A22LS-05-2007 WEIGHT: 0.041 kg</p>
	<p>НАИМЕН.: Передняя качалка системы управления РВ НОМЕР: A22LS-05-2004 ВЕС: 0.077 кг</p>
	<p>НАИМЕН.: Задняя качалка системы управления РВ НОМЕР: A22LS-05-2005 ВЕС: 0.078 кг</p>
	<p>НАИМЕН.: Ролики поддерживающие НОМЕР: A22LS-05-2006 ВЕС: 0.081 кг</p>
	<p>НАИМЕН.: Пружина разгрузочная НОМЕР: A22LS-05-2007 ВЕС: 0.041 кг</p>

	<p>NAME: Cable of mechanical trim tab PART NO.: A22LS-05-2008 WEIGHT: 0.057 kg</p>
	<p>НАИМЕН.: Трос триммера механического НОМЕР: A22LS-05-2008 ВЕС: 0.057 кг</p>
	<p>NAME: Set of fasteners for cable of mechanical trim tab PART NO.: A22LS-05-2009 WEIGHT: 0.013 kg</p>
	<p>НАИМЕН.: Комплект крепежа троса триммера механического НОМЕР: A22LS-05-2009 ВЕС: 0.013 кг</p>
	<p>NAME: Cable of electrically-driven trim tab PART NO.: A22LS-05-2010 WEIGHT: 0.043 kg</p>
	<p>НАИМЕН.: Трос триммера с электроприводом НОМЕР: A22LS-05-2010 ВЕС: 0.043 кг</p>
	<p>NAME: Set of fasteners for cable of electrically-driven trim tab PART NO.: A22LS-05-2011 WEIGHT: 0.031 kg</p>
	<p>НАИМЕН.: Комплект крепежа троса триммера с электроприводом НОМЕР: A22LS-05-2011 ВЕС: 0.031 кг</p>

Rudder control system / Система управления РН

	<p>NAME: Rudder cables (a set) PART NO.: A22LS-05-3000 WEIGHT: 0.408 kg</p> <hr/> <p>НАИМЕН.: Троса руля направления (комплект) НОМЕР: A22LS-05-3000 ВЕС: 0.408 кг</p>
	<p>NAME: Rudder pedal extensions (a set for 1 pilot) PART NO.: A22LS-05-3006 R A22LS-05-3006 L WEIGHT: 0.525 kg</p> <hr/> <p>НАИМЕН.: Удлинитель педаль (комплект для 1-го пилота) НОМЕР: A22LS-05-3006 R A22LS-05-3006 L ВЕС: 0.525 кг</p>
	<p>NAME: Cable fairlead, rear (a set) PART NO.: A22LS-05-3007 WEIGHT: 0.009 kg</p> <hr/> <p>НАИМЕН.: Опора троса задняя (комплект) НОМЕР: A22LS-05-3007 ВЕС: 0.009 кг</p>
	<p>NAME: Rudder control system pulley with bearing PART NO.: A22LS-05-3008 WEIGHT: 0.025 kg</p> <hr/> <p>НАИМЕН.: Ролик системы управления РН с втулкой НОМЕР: A22LS-05-3008 ВЕС: 0.025 кг</p>

Autopilot / Автопилот

	<p>NAME: Autopilot aileron pushrod 140mm PART NO.: A22LS-05-4010 WEIGHT: 0.108 kg</p>
	<p>НАИМЕН.: Тяга автопилота канала крена 140мм НОМЕР: A22LS-05-4010 ВЕС: 0.108 кг</p>
	<p>NAME: Autopilot elevator pushrod 105mm PART NO.: A22LS-05-4011 WEIGHT: 0.087 kg</p>
	<p>НАИМЕН.: Тяга автопилота канала РВ 105мм НОМЕР: A22LS-05-4011 ВЕС: 0.087 кг</p>
	<p>NAME: Autopilot cover PART NO.: A22LS-05-4012 WEIGHT: 0.060 kg</p>
	<p>НАИМЕН.: Щиток автопилота НОМЕР: A22LS-05-4012 ВЕС: 0.060 кг</p>

06. ELECTRICAL SYSTEM / ЭЛЕКТРОСИСТЕМА

Electrical equipment / Электрооборудование

	<p>NAME: GR-40X landing light (a set for T1110 light replacement) PART NO.: A22LS-06-0001 WEIGHT: 0.438 kg</p>
	<p>НАИМЕН.: Посадочная фара GR-40X (комплект для замены фары T1110) НОМЕР: A22LS-06-0001 ВЕС: 0.438 кг</p>
	<p>NAME: Condenser 22000 µF 25V PART NO.: A22LS-06-0002 WEIGHT: 0.093 kg</p>
	<p>НАИМЕН.: Конденсатор 22000мкФ 25В НОМЕР: A22LS-06-0002 ВЕС: 0.093 кг</p>
	<p>NAME: Switch guard PART NO.: A22LS-06-0003 WEIGHT: 0.005 kg</p>
	<p>НАИМЕН.: Защитная планка НОМЕР: A22LS-06-0003 ВЕС: 0.005 кг</p>
	<p>NAME: Toggle switch PART NO.: A22LS-06-0004 WEIGHT: 0.021 kg</p>
	<p>НАИМЕН.: Тумблер НОМЕР: A22LS-06-0004 ВЕС: 0.021 кг</p>

	NAME: Battery straps (a set) PART NO.: A22LS-06-0005 WEIGHT: 0.024 kg
	НАИМЕН.: Ремни аккумулятора (комплект) НОМЕР: A22LS-06-0005 ВЕС: 0.024 кг
	NAME: Li-Ion battery strap PART NO.: A22LS-06-0007 WEIGHT: 0.012 kg
	НАИМЕН.: Ремень Li-Ion аккумулятора НОМЕР: A22LS-06-0007 ВЕС: 0.012 кг
	NAME: Fuel level sensor sealing ring PART NO.: A22LS-06-0006 WEIGHT: 0.009 kg
	НАИМЕН.: Уплотнение датчика уровня топлива НОМЕР: A22LS-06-0006 ВЕС: 0.009 кг

Instruments / Приборное оборудование

	<p>NAME: Airspeed indicator BK-240, range: 0-240 kph, size: 3-1/8" (range markings not included) PART NO.: A22LS-06-1000 WEIGHT: 0.29 kg</p> <p>НАИМЕН.: Указатель скорости ВК-240, диапазон: 0-240 км/ч, размер: Ø80 мм (без маркировки диапазона) НОМЕР: A22LS-06-1000 ВЕС: 0.29 кг</p>
	<p>NAME: Airspeed indicator BK-3A, range: 20-140 knots, size: 3-1/8" (range markings not included) PART NO.: A22LS-06-1001 WEIGHT: 0.37 kg</p> <p>НАИМЕН.: Указатель скорости ВК-3А, диапазон: 20-140 узлов, размер: Ø80 мм (без маркировки диапазона) НОМЕР: A22LS-06-1001 ВЕС: 0.37 кг</p>
	<p>NAME: Altimeter BG-3E, range: 20000 feet, mbar, size: 3-1/8" PART NO.: A22LS-06-1002 WEIGHT: 0.525 kg</p> <p>НАИМЕН.: Высотомер ВГ-3Е, диапазон: 20000 футов, мбар, размер: Ø80 мм НОМЕР: A22LS-06-1002 ВЕС: 0.525 кг</p>
	<p>NAME: Vertical speed indicator BC-2A, range: +/-2000 feet/min, size: 3-1/8" PART NO.: A22LS-06-1003 WEIGHT: 0.343 kg</p> <p>НАИМЕН.: Вариометр ВС-2А, диапазон: +/-2000 футов/мин, размер: Ø80 мм НОМЕР: A22LS-06-1003 ВЕС: 0.343 кг</p>

	<p>NAME: Compass CM-13, size: 2-1/4" PART NO.: A22LS-06-1004 WEIGHT: 0.27 kg</p> <hr/> <p>НАИМЕН.: Компас CM-13, размер: Ø57 мм НОМЕР: A22LS-06-1004 ВЕС: 0.27 кг</p>
	<p>NAME: Compass CM-24 PART NO.: A22LS-06-1005 WEIGHT: 0.3 kg</p> <hr/> <p>НАИМЕН.: Компас CM-24 НОМЕР: A22LS-06-1005 ВЕС: 0.3 кг</p>
	<p>NAME: Slip indicator, size: 2-1/4" PART NO.: A22LS-06-1006 WEIGHT: 0.04 kg</p> <hr/> <p>НАИМЕН.: Указатель скольжения, размер: Ø57 мм НОМЕР: A22LS-06-1006 ВЕС: 0.04 кг</p>
	<p>NAME: Fuel level indicator, size: 2-1/16" PART NO.: A22LS-06-1007 WEIGHT: 0.1 kg</p> <hr/> <p>НАИМЕН.: Индикатор уровня топлива, размер: Ø52 мм НОМЕР: A22LS-06-1007 ВЕС: 0.1 кг</p>

07. СОСКРИТ EQUIPMENT / ОБОРУДОВАНИЕ КАБИНЫ

Seats / Сиденья

	<p>NAME: Seat assembly PART NO.: A22LS-07-0004 WEIGHT: 1.955 kg</p>
	<p>НАИМЕН.: Сиденье в сборе НОМЕР: A22LS-07-0004 ВЕС: 1.955 кг</p>
	<p>NAME: Seat framework PART NO.: A22LS-07-0002 WEIGHT: 0.96 kg</p>
	<p>НАИМЕН.: Каркас сиденья НОМЕР: A22LS-07-0002 ВЕС: 0.96 кг</p>
	<p>NAME: Seat cushion PART NO.: A22LS-07-0003 WEIGHT: 0.885 kg</p>
	<p>НАИМЕН.: Подушка сиденья НОМЕР: A22LS-07-0003 ВЕС: 0.885 кг</p>
	<p>NAME: Fastener kit for one seat PART NO.: A22LS-07-0005 WEIGHT: 0.063 kg</p>
	<p>НАИМЕН.: Комплект крепежа для одного сидения НОМЕР: A22LS-07-0005 ВЕС: 0.063 кг</p>



Harness belts / Привязная система

NAME: **Harness belts (a set for 2 pilots)**
PART NO.: **A22LS-07-1000**
WEIGHT: **1.71 kg**

НАИМЕН.: **Привязные ремни (комплект для 2-х пилотов)**
НОМЕР: **A22LS-07-1000**
ВЕС: **1.71 кг**

Heating / Отопление

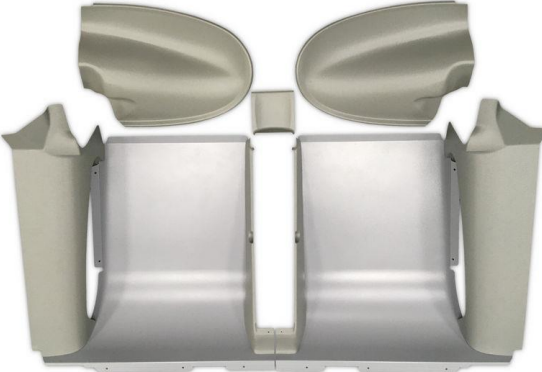
Interior and baggage compartment / Интерьер и багажник

	<p>NAME: Lining panels PART NO.: A22LS-07-4000 WEIGHT: 1.772 kg</p>
	<p>НАИМЕН.: Потолок НОМЕР: A22LS-07-4000 ВЕС: 1.772 кг</p>
	<p>NAME: Heating partition panel, central PART NO.: A22LS-07-4006 WEIGHT: 0.119 kg</p>
	<p>НАИМЕН.: Панель центральная НОМЕР: A22LS-07-4006 ВЕС: 0.119 кг</p>
	<p>NAME: Heating partition panel, rear PART NO.: A22LS-07-4007 WEIGHT: 0.161 kg</p>
	<p>НАИМЕН.: Панель задняя НОМЕР: A22LS-07-4007 ВЕС: 0.161 кг</p>

08. CONSUMABLE MATERIALS / РАСХОДНЫЕ МАТЕРИАЛЫ

Oils and fluids / Масла и жидкости систем

	<p>NAME: ATF hydraulic fluid, 5 l PART NO.: A22LS-08-0001 WEIGHT: 4.5 kg</p>
	<p>NAME: Mobil 1 (5W-50) engine oil, 4 l PART NO.: A22LS-08-0002 WEIGHT: 3.6 kg</p>
	<p>NAME: Mobil antifreeze (concentrated), 5 l PART NO.: A22LS-08-0003 WEIGHT: 5.5 kg</p> <p>НАИМЕН.: Антифриз Mobil (концентрат), 5 л НОМЕР: A22LS-08-0003 ВЕС: 5.5 кг</p>

Sealants / Герметики

	<p>NAME: 3M polyurethane sealant, 310 ml PART NO.: A22LS-08-1000 WEIGHT: 0.35 kg</p>
	<p>NAME: Acrylic sealant for glazing PART NO.: A22LS-08-1001 WEIGHT: 0.3 kg</p>
	<p>НАИМЕН.: Герметик полиуретановый 3М, 310 мл НОМЕР: A22LS-08-1000 ВЕС: 0.35 кг</p> <p>НАИМЕН.: Герметик акриловый для уплотнения остекления НОМЕР: A22LS-08-1001 ВЕС: 0.3 кг</p>

Primers and paints / Грунты и краски

	<p>NAME: Terostat-8517H primer, 25 ml PART NO.: A22LS-08-2000 WEIGHT: 0.06 kg</p>
	<p>НАИМЕН.: Грунт Terostat - 8517H, 25 мл НОМЕР: A22LS-08-2000 ВЕС: 0.06 кг</p>
	<p>NAME: Glasurit primer, 0.5 l + 1.0 l PART NO.: A22LS-08-2001 WEIGHT: 1.75 kg</p>
	<p>НАИМЕН.: Грунт Glasurit, 0.5 л + 1.0 л НОМЕР: A22LS-08-2001 ВЕС: 1.75 кг</p>
	<p>NAME: EcoFill primer, 3.8 l PART NO.: A22LS-08-2002 WEIGHT: 4.9 kg</p>
	<p>НАИМЕН.: Грунт EcoFill, 3.8 л НОМЕР: A22LS-08-2002 ВЕС: 4.9 кг</p>

CATALOG STRUCTURE / СТРУКТУРА КАТАЛОГА

A22LS (A22L2)

01 - AIRFRAME / ПЛАНЕР

- 0001 - 0999 - **Fuselage** / Фюзеляж
- 1000 - 1999 - **Wing** / Крыло
- 2000 - 2999 - **Horizontal empennage** / Горизонтальное оперение
- 3000 - 3999 - **Vertical empennage** / Вертикальное оперение
- 4000 - 4999 - **Glass** / Остекление
- 5000 - 5999 - **Doors** / Двери

02 - LANDING GEAR / ШАССИ

- 0001 - 0999 - **Nose leg** / Передняя стойка
- 1000 - 1999 - **Main leg** / Основная стойка
- 2000 - 2999 - **Fairings** / Обтекатели
- 3000 - 3999 - **Mud-screens** / Щитки
- 4000 - 4999 - **Wheels** / Колеса
- 5000 - 5999 - **Brakes** / Тормоза

03 - ENGINE AND ITS SYSTEMS / ДВИГАТЕЛЬ И ЕГО СИСТЕМЫ

- 0001 - 0999 - **Engine mount** / Моторама
- 1000 - 1999 - **Control system** / Система управления
- 2000 - 2999 - **Fuel system** / Топливная система
- 3000 - 3999 - **Oil system** / Маслосистема
- 4000 - 4999 - **Cooling system** / Система охлаждения
- 5000 - 5999 - **Exhaust system** / Выхлопная система

04 - PROPELLER / ВОЗДУШНЫЙ ВИНТ

- 0001 - 0999 - **Spinner** / Кок
- 1000 - 1999 - **Propeller** / Винт

05 - AIRPLANE CONTROL SYSTEM / СИСТЕМА УПРАВЛЕНИЯ САМОЛЕТОМ

- 0001 - 0999 - **Control system levers** / Посты системы управления
- 1000 - 1999 - **Aileron control system** / Система управления элеронами
- 2000 - 2999 - **Elevator control system** / Система управления РУ
- 3000 - 3999 - **Rudder control system** / Система управления РН
- 4000 - 4999 - **Autopilot** / Автопилот

06 - ELECTRICAL SYSTEM / ЭЛЕКТРОСИСТЕМА

- 0001 - 0999 - **Electrical equipment** / Электрооборудование
- 1000 - 1999 - **Instruments** / Приборное оборудование

07 - COCKPIT EQUIPMENT / ОБОРУДОВАНИЕ КАБИНЫ

- 0001 - 0999 - **Seats** / Сиденья
- 1000 - 1999 - **Harness belts** / Привязная система
- 2000 - 2999 - **Heating** / Отопление
- 3000 - 3999 - **Instrument compartment** / Приборный отсек
- 4000 - 4999 - **Interior and baggage compartment** / Интерьер и багажник
- 5000 - 5999 - **Rescue system** / Спассистема

08 - CONSUMABLE MATERIALS / РАСХОДНЫЕ МАТЕРИАЛЫ

- 0001 - 0999 - **Oils and fluids** / Масла и жидкости систем
- 1000 - 1999 - **Sealants** / Герметики
- 2000 - 2999 - **Primers and paints** / Грунты и краски